



PRODUCT INFORMATION

ECO FTS III

■ SYSTEM TECHNOLOGY FOR THE DOOR



ECO FTS III



Product characteristics

Door width acc. to EN	≤ 1.400 mm	3 – 6
Dimensions (incl. mounting plate)	Length in mm	409
	Depth in mm	51,5
	Height in mm	65
Supply voltage		24 V DC
Mounting types	DIN-L = DIN-R	■
	Hinge side = Hinge-opposite side	■
	Standard mounting = Head mounting	■
Latching speed (continuously adjustable)		■
Closing speed (continuously adjustable)		■
Door opening angle		up to 180°
Free-swing function can be activated		1 - 180°
Degree of protection		IP 20
Tested acc. to EN		EN 1154
		EN 1155
Suitable for fire and smoke protection doors		F
Certified according to EU directive		CE

■ Yes
- No
□ Option

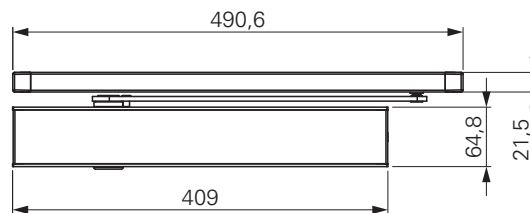

Dimensions: ECO FTS III



ECO FTS III ■ ... for special applications

With the new ECO FTS III and the ECO GS-HF slide rail, ECO Schulte is launching a hold-open device for use in projects with barrier-free access. Accordingly, the main areas of application for the free swing door closer include retirement homes, kindergartens, schools, hospitals and other projects in which doors must be able to be opened and closed with as little force as possible.

The ECO FTS III can be used in all types of installation, a variant both for DIN-L and DIN-R, hinge and hinge-opposite side, as well as for standard and head mounting. In combination with the ECO SR III, the ECO FTS III can also be used on double-leaf doors. The connecting cable to the ECO FTS III can be surface-mounted or invisible (internal cable transition).

The free-swing function is activated from the first degree of opening angle, so that the door only has to be opened once to the desired angle. After that, the door can be moved freely without any disturbing resistance (door opening torques below 25 Nm- **DIN EN 18040**).

The hold-open device is triggered e.g. by the on-site fire alarm system or an additional manual push-button or by switching off the 24 V supply voltage (power failure).

Due to its identical appearance to the ECO Newton door closer generation, it fits perfectly into the ECO door closer world. This means that all requirements for fire and smoke protection or function doors can be fulfilled in the building with the same, visually and functionally high-quality standard.



Norms

EN 1154 EN 1155 F CE

Advantages / USPs



Infinitely adjustable closing force EN 3 – 6.
High-quality, thermostable valves for stepless adjustment of latching- and closing speed.



Can be combined with slide rail GS-HF in mounting type DIN L = DIN R, hinge side = hinge-opposite side, standard mounting = head mounting. Can be combined with ECO SR III and ECO SR BG III.



Uniform ECO Newton design, therefore visually perfectly combinable with the ECO Newton door closer series. Vandalism-proof U-click-cover made of stainless steel, matt brushed.



Simple mounting with concealed mounting plate and prefabricated plug-in connections.



Optional stainless steel full cover for closer body and slide rail.



Convenient combi-pack for set FTS III with GS-HF and all accessories.

Advantages / USPs

- Free-swing door closer ECO FTS III with infinitely variable closing force **EN 3 – 6**, tested and certified according to **EN 1154** and **EN 1155**, for use on fire and smoke protection doors, especially for barrier-free construction according to **DIN EN 18040**.
- One model ECO FTS III for all mounting types:
DIN-L = DIN-R
Hinge side = hinge-opposite side
Standard mounting = head mounting

Can also be used in combination with ECO SR III / SR BG III for 2-leaf fire and smoke protection doors.
- Prefabricated components enable simple, fast and error-free assembly.
- Selection of mounting type with concealed (on-site device required) or surface-mounted cable duct.
- Height-adjustable slide rail ECO GS-HF, adjustment range ± 3 mm.
- Slide rail flush with FTS III body, thus visually elegant design.

Technical parameters

- Opening angle: 0 - 180°
- Free-swing function can be activated: 1 - 180°
- Max. Return angle: under 5°
- Follow-up movement 48 h: under 2°
- Door thickness up to 100 mm possible:
X-Dimension: 60 - 95 mm
Y-Dimension: bis 57 mm
- SK - Closing force, continuously
- SG - Closing speed, continuously
- ES - Latching speed, continuously

Technical data

ECO FTS III (EN 3 – 6)

Door closer with electromechanical free-swing function

- **Control by:** external fire alarm systems
- **Locking point:** 1-180° (free-swing function)
- **Supply Voltage:** 24 V DC ±15
- **Power consumption:** 2.7 watts (114 mA)
- **Mounting:** DIN-L = DIN-R, hinge side = hinge-opposite side, standard mounting = head mounting
- **Operating range:** -15 to +45°, max. relative humidity: 95%
- **Degree of protection:** IP 20
- **Slide rails:** ECO GS-HF, ECO SR (BG) III

Suitable for the following door types



Wooden door



Steel door



Profile frame door

Suitable for the following object types



Health



Public



Education



Office

Tender text

ECO Set FTS III GS-HF

Slide rail door closer with free-swing function with adjustable closing force **EN 3 - 6**
 For use on single-leaf fire and smoke control doors up to 1,400 mm
 Certified according to **EN 1154** and **EN 1155**
 Door closer aluminium design body with integrated, invisible mounting plate, stainless steel cover with vandalism-proof clip technology,
 Closing speed and latching speed continuously adjustable.
 Opening angle max. 180°, free-swing function 1- 180°. Temperature range from -15 to + 45°, max. 95% relative humidity
 With free-swing lever arm and height-adjustable slide rail ECO GS-HF
 Mounting optionally with concealed or surface-mounted cable duct

One model for all mounting types:
 DL=DR, hinge side=hinge-opposite side, standard mounting=head mounting.
 Surface finish:
 () Silver RAL 9006 (cover stainless steel, matt)
 () White RAL 9016
 () RAL at choice ...
 () Stainless steel, matt

Article numbers



Free-swing door closer set with lever arm and with slide rail GS-HF	Colour	Article number
Set ECO FTS III GS-HF (3-6)	Silver RAL 9006	5030064525
Set ECO FTS III GS-HF (3-6)	White RAL 9016	5030064771
Set ECO FTS III GS-HF (3-6)	Black RAL 9005	on request
Set ECO FTS III GS-HF (3-6)	Stainless steel	on request



Free swing door closer with lever arm, without slide rail (for combination with ECO SR (BG) III))	Colour	Article number
ECO FTS III (3-6)	Silver RAL 9006	5030064770
ECO FTS III (3-6)	White RAL 9016	5030064769
ECO FTS III (3-6)	Black RAL 9005	on request
ECO FTS III (3-6)	Stainless steel	on request

Mounting

Hinge side

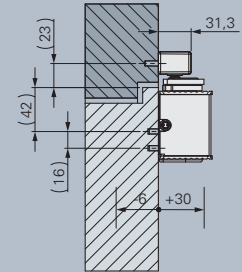
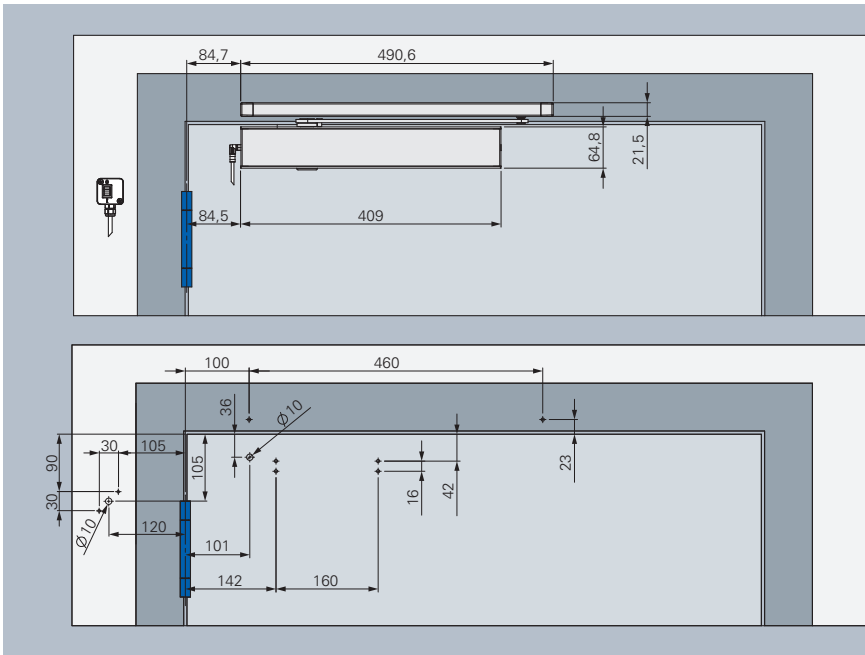

Standard mounting, hinge side, DIN-L- ECO FTS III

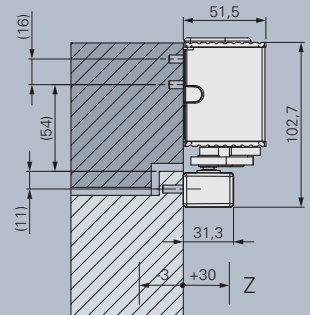
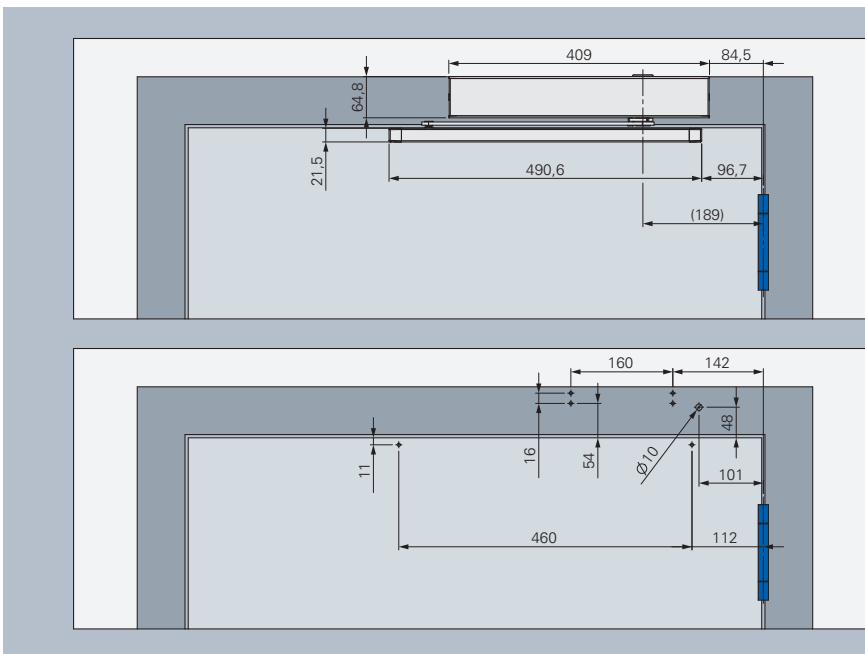

Head mounting, hinge side, DIN-R- ECO FTS III

Mounting

Hinge-opposite side

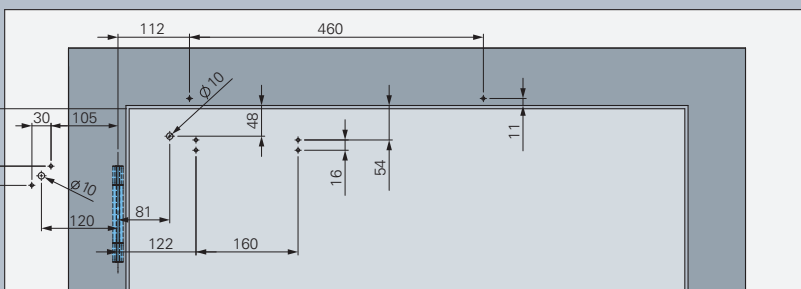
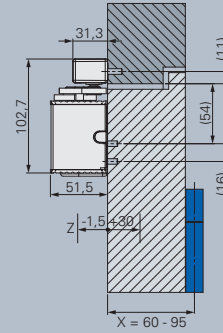
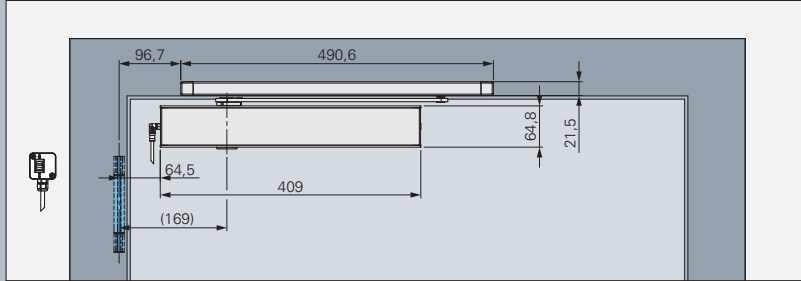

Standard mounting, hinge-opposite side, DIN-R- ECO FTS III

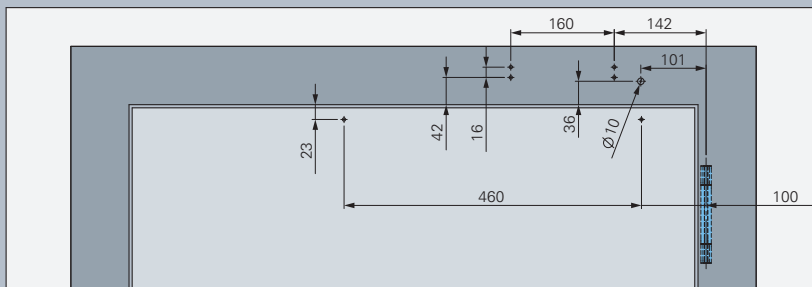
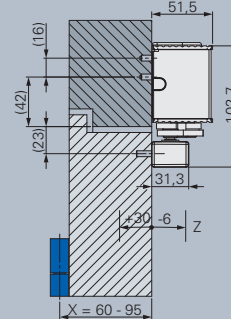
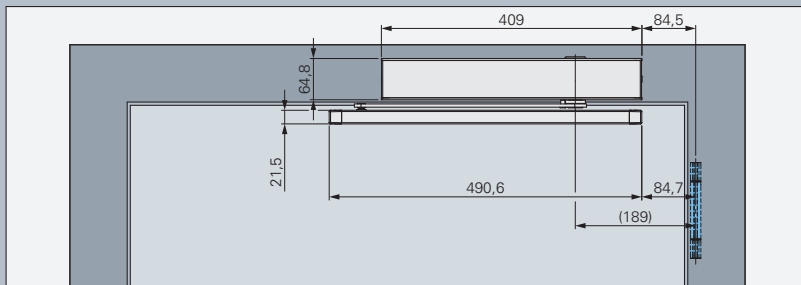

Head mounting, hinge-opposite side, DIN-R- ECO FTS III

ECO Schulte GmbH & Co. KG

Iserlohner Landstraße 89

D-58706 Menden

Telephone +49 2373 9276 - 0

Telefax +49 2373 9276 - 40

info@eco-schulte.de

www.eco-schulte.de

■ SYSTEM TECHNOLOGY FOR THE DOOR

