



ECO D-110 Security handle sets

Product information



■ SYSTEM TECHNOLOGY FOR THE DOOR

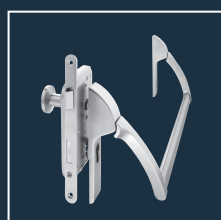
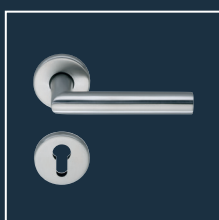

Product characteristics

Tested acc. to	EN 1906								
With 9 mm spindle acc. to DIN 18273 fire protection tested	F								
Lever form for escape doors and emergency exits	EN 179								
Tested acc. to	DIN 18 257								
Fixable bearing	■								
Steel base in inner and outer plate	■								
Concealed through-screw technology	■								
Inside with lever	■								
Classification key EN 1906									
<table border="1"> <tr> <td>4</td> <td>7</td> <td>-</td> <td>B1</td> <td>1</td> <td>4</td> <td>4</td> <td>U</td> </tr> </table>		4	7	-	B1	1	4	4	U
4	7	-	B1	1	4	4	U		
■ Yes – No □ Option									

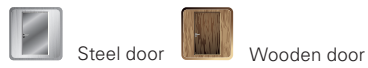
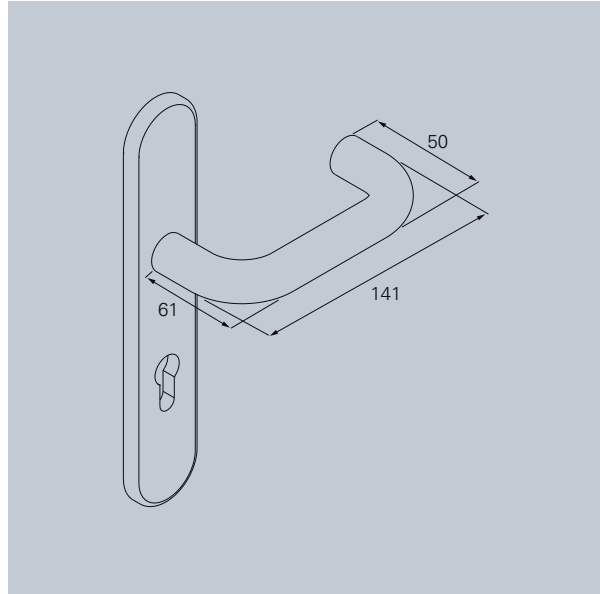

Material:



ER
Stainless steel



Al
Aluminium

Bearing technology:



PRODUCT FAMILY D-100

Standard handle

Long- / short plate handle



D-110

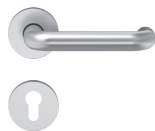

D-120

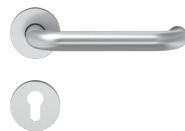

D-190



D-110



D-110

Oval rose handle

Security handle

Window handle

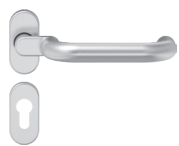

D-115



D-116



D-110



D-111



D-116



F-110

D-110 Long plate security handle ES 3



D-110 Long plate security handle ES 3 with OGI

Fixed in maintenance-free friction bearing.
 Anti-burglary protection class ES 3 / class 4.
 Available with knob K-130 and grip plates G-160 and G-180.
 Utilization category class 4. Positioning studs $\varnothing 8 \times 5$ mm
 Outside: mounting height 15 mm
 Fastening bolts (short) $\varnothing 12 \times 9$ mm on request. FS-92 on request.

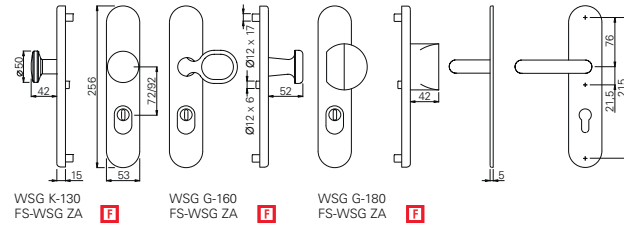

OGI - LONG PLATE SECURITY HANDLE

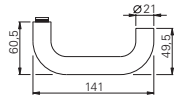

= 4 7 - B1 1 4 4 U



				Sets ZA			
	\varnothing	Distance	∇				
	21 mm	72 mm	8 mm	713312.46	713342.46	713322.46	713362.46
	21 mm	72 mm	9 mm	763312.46	763342.46	763322.46	763362.46
	21 mm	92 mm	10 mm	743512.46	743542.46	743522.46	743562.46

Finish: Stainless steel satin brushed, further colours on request

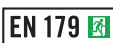
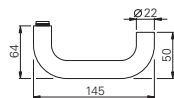

= 4 7 - D1 1 4 4 U



				Sets ZA			
	\varnothing	Distance	∇				
	22 mm	72 mm	8 mm	713312.30	713342.30	713322.30	713362.30
	22 mm	72 mm	9 mm	763312.30	763342.30	763322.30	763362.30
	22 mm	92 mm	10 mm	743512.30	743542.30	743522.30	743562.30

Finish: Aluminium anodized F1, further colours on request

The execution ZA is designed for cylinder projections of 11 – 14 mm.

Standard handle for door thicknesses: 38 – 45 mm. Fire protection doors and Panic doors for door thicknesses: 40 – 65 mm. Please advise door thickness when ordering

D-110 Long plate security handle ES 2



D-110 Long plate security handle ES 2 with OGL

Fixed in maintenance-free friction bearing.
 Anti-burglary protection class ES 2 / class 3.
 Available with knob K-130 and grip plates G-160 and G-170.
 Utilization category class 4. Positioning studs $\varnothing 8 \times 5$ mm
 Outside: mounting height 15 mm
 Fastening bolts (short) $\varnothing 12 \times 9$ mm on request. FS-92 on request.

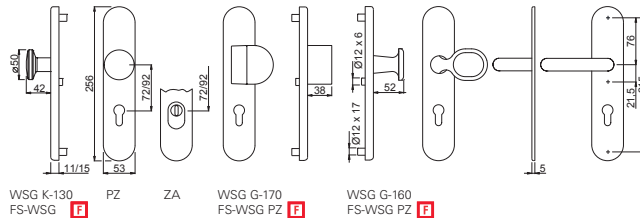

OGL – LONG PLATE SECURITY HANDLE

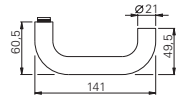

F = 4 7 - B1 1 4 3 U



	Ø	Distance	∇	Sets PZ				Sets ZA			
S	21 mm	72 mm	8 mm	712311.46	712341.46	712321.46	712361.46	712312.46	712342.46	712322.46	712362.46
F	21 mm	72 mm	9 mm	762311.46	762341.46	762321.46	762361.46	762312.46	762342.46	762322.46	762362.46
	21 mm	92 mm	10 mm	742511.46	742541.46	742521.46	742561.46	742512.46	742542.46	742522.46	742562.46

Finish: Stainless steel satin brushed, further colours on request

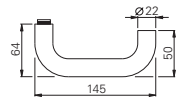

F = 4 7 - D1 1 4 3 U



	Ø	Distance	∇	Sets PZ				Sets ZA			
S	22 mm	72 mm	8 mm	712311.30	712341.30	712321.30	712361.30	712312.30	712342.30	712322.30	712362.30
F	22 mm	72 mm	9 mm	762311.30	762341.30	762321.30	762361.30	762312.30	762342.30	762322.30	762362.30
	22 mm	92 mm	10 mm	742511.30	742541.30	742521.30	742561.30	742512.30	742542.30	742522.30	742562.30

Finish: Aluminium anodized F1, further colours on request

The execution ZA is designed for cylinder projections of 11 – 14 mm.

S Standard handle for door thicknesses: 38 – 45 mm. **F** Fire protection doors and **A** Panic doors for door thicknesses: 40 – 65 mm. Please advise door thickness when ordering

D-110 Long plate security handle ES 2



D-110 Long plate security handle ES 2 with OGL

Fixed in maintenance-free friction bearing.

Anti-burglary protection class ES 2 / class 3.

Available with knob K-130

Utilization category class 4. Positioning studs $\varnothing 8 \times 5$ mm

Outside: Mounting height 15 mm (11 mm on request)

Fastening bolts (short) $\varnothing 12 \times 9$ mm on request. FS-92 on request.

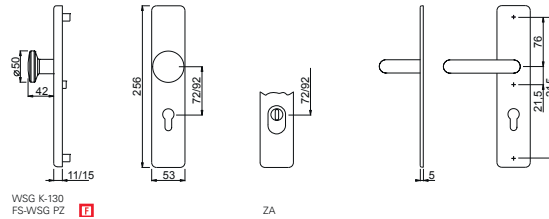

OGL – LONG PLATE SECURITY HANDLE

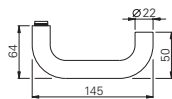

4	7	-	D1	1	4	3	U
---	---	---	----	---	---	---	---



	\varnothing	Distance	∇	Sets PZ		Sets ZA	
	22 mm	72 mm	8 mm	718311.30	718341.30	718312.30	718342.30
	22 mm	72 mm	9 mm	768311.30	768341.30	768312.30	768342.30
	22 mm	92 mm	10 mm	748511.30	748541.30	748512.30	748542.30

Finish: Aluminium anodized F1, further colours on request

The execution ZA is designed for cylinder projections of 11 – 14 mm.

Standard handle for door thicknesses: 38 – 45 mm. Fire protection doors and Panic doors for door thicknesses: 40 – 65 mm. Please advise door thickness when ordering

D-110 Long plate security handle ES 1



D-110 Long plate security handle ES 1 with OGI

Fixed in maintenance-free friction bearing. Anti-burglary protection class ES 1 / Class 2. Available with knob K-130

Utilization category class 4. Positioning studs $\varnothing 8 \times 5$ mm

Outside: Mounting height 15 mm (11 mm on request)

Fastening bolts (short) $\varnothing 12 \times 9$ mm on request. FS-92 on request.

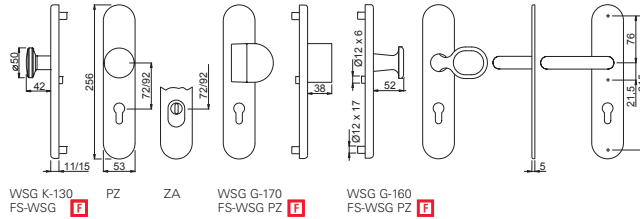

OGI – LONG PLATE SECURITY HANDLE

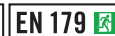
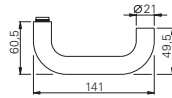

F = 4 7 - B1 1 4 2 U



	Ø	Distance	∇	Sets PZ				Sets ZA			
S	21 mm	72 mm	8 mm	711311.46	711341.46	711321.46	711371.46	711312.46	711342.46	711322.46	711372.46
F	21 mm	72 mm	9 mm	761311.46	761341.46	761321.46	761371.46	761312.46	761342.46	761322.46	761372.46
	21 mm	92 mm	10 mm	741511.46	741541.46	741521.46	741571.46	741512.46	741542.46	741522.46	741572.46

Finish: Stainless steel satin brushed, further colours on request

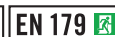
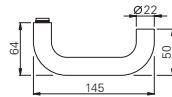

F = 4 7 - D1 1 4 2 U



	Ø	Distance	∇	Sets PZ				Sets ZA			
S	22 mm	72 mm	8 mm	711311.30	711341.30	711321.30	711371.30	711312.30	711342.30	711322.30	711372.30
F	22 mm	72 mm	9 mm	761311.30	761341.30	761321.30	761371.30	761312.30	761342.30	761322.30	761372.30
	22 mm	92 mm	10 mm	741511.30	741541.30	741521.30	741571.30	741512.30	741542.30	741522.30	741572.30

Finish: Aluminium anodized F1, further colours on request

The execution ZA is designed for cylinder projections of 11 – 14 mm.

S Standard handle for door thicknesses: 38 – 45 mm. **F** Fire protection doors and **A** Panic doors for door thicknesses: 40 – 65 mm. Please advise door thickness when ordering

D-110 Long plate security handle ES 1



D-110 Long plate security handle ES 1 with OGL

Fixed in maintenance-free friction bearing. Anti-burglary protection class ES 1 / Class 2. Available with knob K-130

Utilization category class 4. Positioning studs $\varnothing 8 \times 5$ mm

Outside: Mounting height 15 mm (11 mm on request)

Fastening bolts (short) $\varnothing 12 \times 9$ mm on request. FS-92 on request.

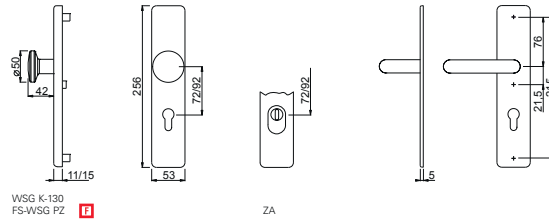

OGL – LONG PLATE SECURITY HANDLE

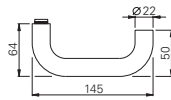

= 4 7 - B1 1 4 2 U



	\varnothing	Distance	∇	Sets PZ		Sets ZA	
	22 mm	72 mm	8 mm	717311.30	717341.30	717312.30	717342.30
	22 mm	72 mm	9 mm	767311.30	767341.30	767312.30	767342.30
	22 mm	92 mm	10 mm	747511.30	747541.30	747512.30	747542.30

Finish: Aluminium anodized F1, further colours on request

The execution ZA is designed for cylinder projections of 11 – 14 mm.

Standard handle for door thicknesses: 38 – 45 mm. Fire protection doors and Panic doors for door thicknesses: 40 – 65 mm. Please advise door thickness when ordering

D-110 Long plate security handle ES 0

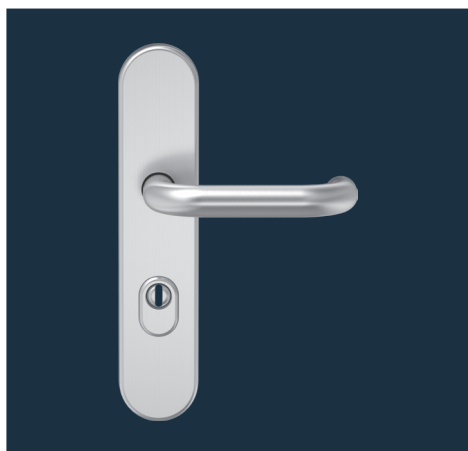

D-110 Long plate security handle ES 0 with OGL

Anti-burglary protection class ES 0

Available with knob K-130 and grip plate G-160.

Positioning studs $\varnothing 8 \times 5$ mm





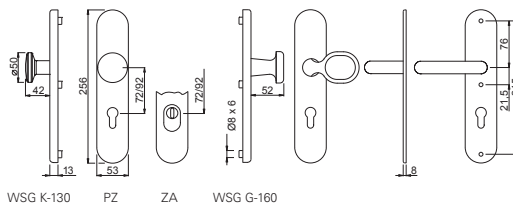

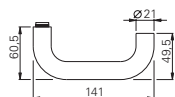

Outside: Mounting height 13 mm on request.

FS-92 on request.



OGL – LONG PLATE SECURITY HANDLE



	Ø	Distance	▧	Sets PZ			Sets ZA		
									
	21 mm	72 mm	8 mm	715311.46	715341.46	715321.46	715312.46	715342.46	715322.46
	21 mm	92 mm	10 mm				745512.46	745542.46	745522.46

Finish: Stainless steel satin brushed, further colours on request

The execution ZA is designed for cylinder projections of 11 – 14 mm.

 Standard handle for door thicknesses: 38 – 45 mm.  Fire protection doors and  Panic doors for door thicknesses: 40 – 65 mm. Please advise door thickness when ordering



ECO

ECO Long plate security handle ES 0 · D-110

D-110 Long plate security handle ES 0



D-110 Long plate security handle ES 0 with OGL

Anti-burglary protection class ES 0

Available with knob K-130.

Positioning studs $\varnothing 8 \times 5$ mm

Outside: Mounting height 13 mm on request.

FS-92 on request

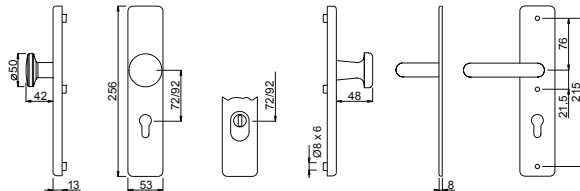

WSG K-130
FS-WSG PZ

ZA

OGL – LONG PLATE SECURITY HANDLE

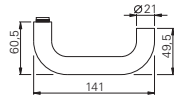

	\varnothing	Distance	∇	Sets PZ		Sets ZA	
	21 mm	72 mm	8 mm	719311.46	719341.46	719312.46	719342.46
	21 mm	88 mm	8,5 mm	719911.46	719941.46	719912.46	719942.46
	21 mm	92 mm	10 mm			749512.46	749542.46

Finish: Stainless steel satin brushed, further colours on request

The execution ZA is designed for cylinder projections of 11 – 14 mm.

Standard handle for door thicknesses: 38 – 45 mm. Fire protection doors and Panic doors for door thicknesses: 40 – 65 mm. Please advise door thickness when ordering

D-110 Short plate security handle ES 1



D-110 Long plate security handle ES 1 with OGL

Fixed in maintenance-free friction bearing. Anti-burglary protection class ES 1 / Class 2. Available with knob K-130

Utilization category class 4. Positioning studs $\varnothing 8 \times 5$ mm

Outside: Mounting height 15 mm (11 mm on request)

Fastening bolts (short) $\varnothing 12 \times 9$ mm on request. FS-92 on request

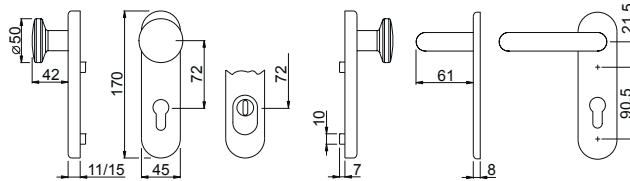

WSG K-130
FS-WSG PZ

ZA

OGL – SHORT PLATE SECURITY HANDLE

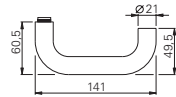

F = 4 7 - B1 1 4 2 U



	\varnothing	Distance	∇	Sets PZ		Sets ZA	
S	21 mm	72 mm	8 mm	714311.46	714341.46	714312.46	714342.46
F	21 mm	72 mm	9 mm	764311.46	764341.46	764312.46	764342.46

Finish: Stainless steel satin brushed, further colours on request

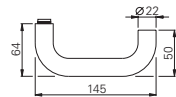

F = 4 7 - D1 1 4 2 U



	\varnothing	Distance	∇	Sets PZ		Sets ZA	
S	22 mm	72 mm	8 mm	714311.30	714341.30	714312.30	714342.30
F	22 mm	72 mm	9 mm	764311.30	764341.30	764312.30	764342.30

Finish: Aluminium anodized F1, further colours on request

The execution ZA is designed for cylinder projections of 11 – 14 mm.

S Standard handle for door thicknesses: 38 – 45 mm. F Fire protection doors and A Panic doors for door thicknesses: 40 – 65 mm. Please advise door thickness when ordering

ECO Schulte GmbH & Co. KG
Iserlohner Landstraße 89
D - 58706 Menden

Telefon: +49 2373/9276-0
Fax: +49 2373/9276-40

info@eco-schulte.de
www.eco-schulte.de

© ECO Schulte GmbH & Co. KG - Änderungen vorbehalten
© ECO Schulte GmbH & Co. KG - Subject to change