

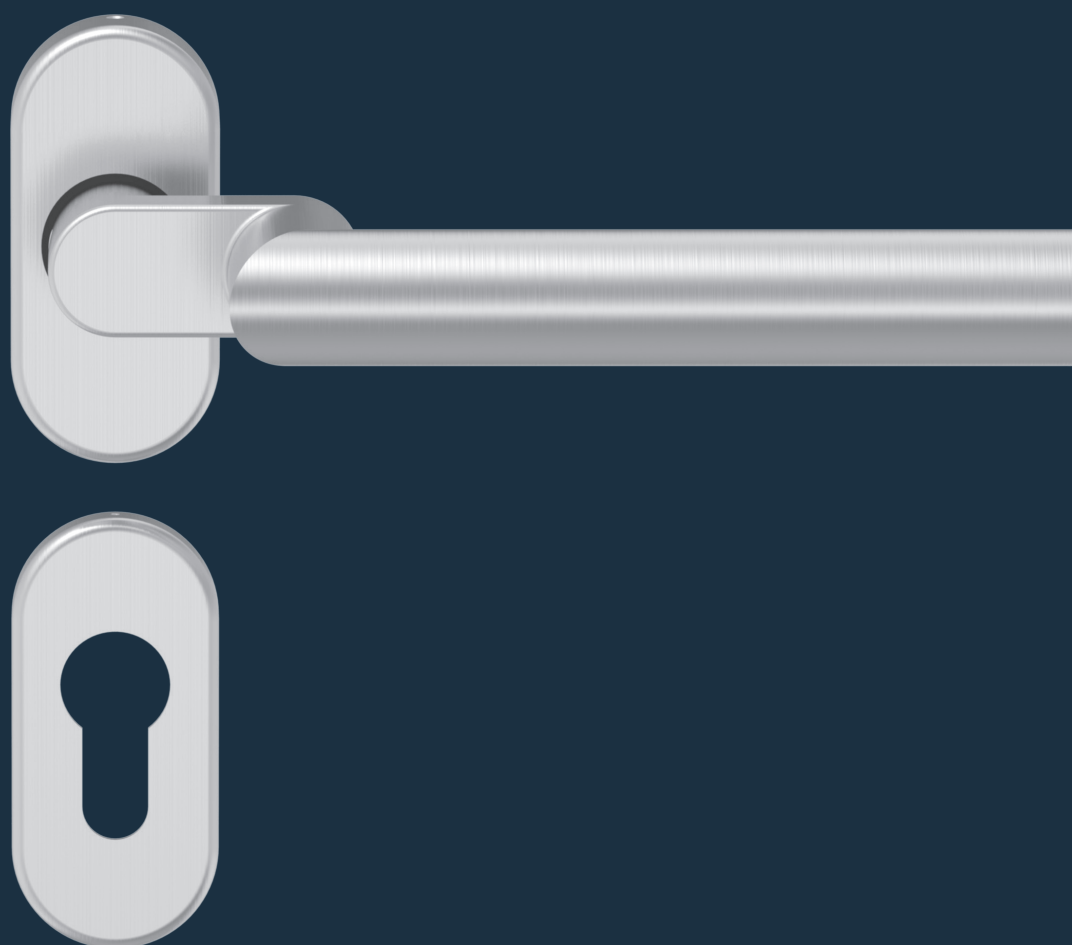

ECO D-315

Product information



■ SYSTEM TECHNOLOGY FOR THE DOOR

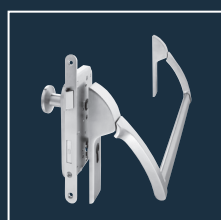
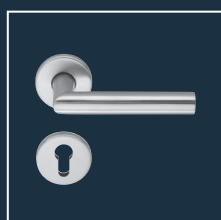

Product characteristics

Tested acc. to	EN 1906
With 9 mm spindle acc. to DIN 18273 fire protection tested	F
Lever form for escape doors and emergency exits	-
Restoring spring	■
Fixable bearing	■
Steel base with positioning studs	■
Concealed through-screw technology	■
DIN left / right	■

Classification key EN 1906

4	7	-	B1	1	4	0	A
---	---	---	----	---	---	---	---

■ Yes - No □ Option

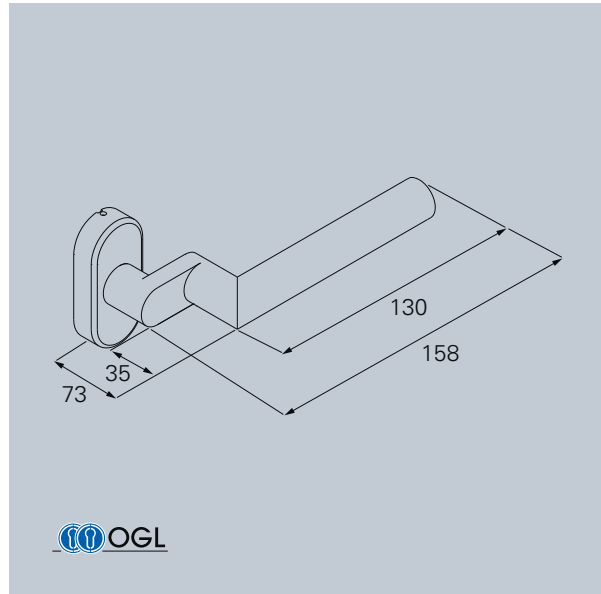
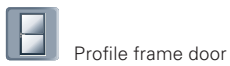

Material:



Bearing technology:



PRODUCT FAMILY D-300

Standard handle



D-310 D-330

Long- / short plate handle

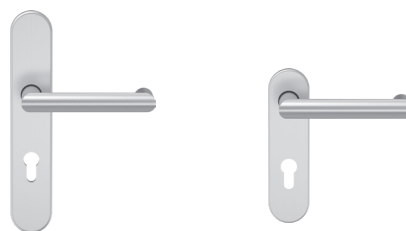

D-330 D-330

Oval rose handle

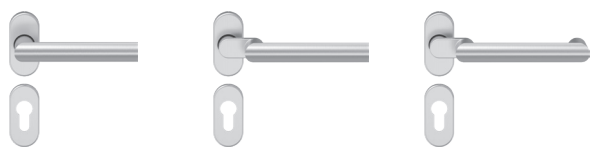

D-310 D-315 D-335

Security handle

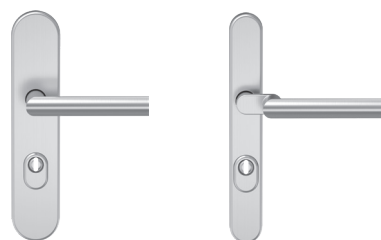

D-310 D-315

Window handle



F-310

D-315 Oval rose

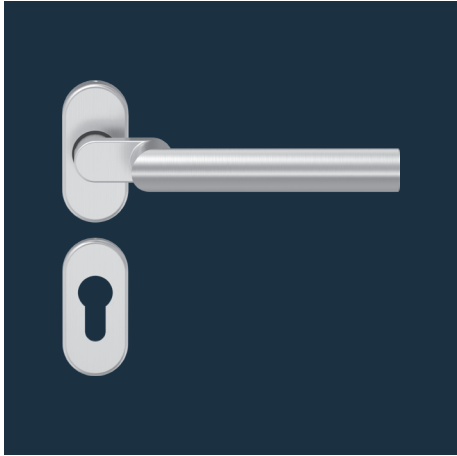

D-315 Oval rose with OGL – friction bearing technology

Lever guidance consists of a closed, maintenance-free friction bearing with self-lubricating plastic. Available with fixed knob or turnable knob and powerful return spring. Flush ground rose, no bigger lever drillings necessary. Available with or without positioning studs.

Utilization category class 4, Positioning studs Ø 8 x 5 mm

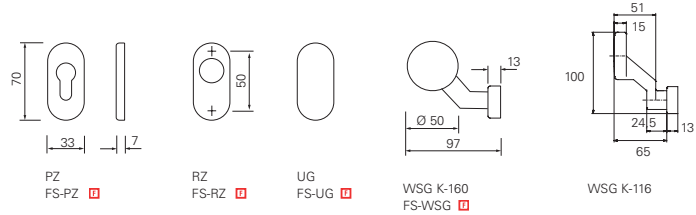

OGI – OVAL ROSE HANDLE

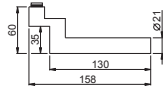

EN 1906 **F**

F = 4 7 - B1 1 4 0 A

			Sets			Knob			Rose		
	Ø	∇									
S	21 mm	8 mm	178422.46	185205.46	185210.46	178218.46	178200.46	178202.46	176850.46	176852.46	176851.46
F	21 mm	9 mm	178420.46	385205.46	385210.46	178217.46	178200.46	178204.46	176850.46	176852.46	176851.46

Finish: Stainless steel satin brushed. PVD and polished on request

*Base escutcheon incl. fire-proof plate

OGI – OVAL ROSE HANDLE

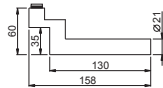

EN 1906 **F**

F = 4 7 - D1 1 4 0 A

			Sets			Knob			Rose		
	Ø	∇									
S	21 mm	8 mm	178422.30	185205.30	185210.30	178218.30	178200.30	178202.30	177850.30	177852.30	177851.30
F	21 mm	9 mm	178420.30	385205.30	385210.30	178217.30	178200.30	178204.30	177850.30	177852.30	177851.30

Finish: Aluminium anodized F1 and F9, further colours on request**

*Base escutcheon incl. fire-proof plate

** Please note our notes on the following pages.

ECO Schulte GmbH & Co. KG
Iserlohner Landstraße 89
D - 58706 Menden

Telefon: +49 2373/9276-0
Fax: +49 2373/9276-40

info@eco-schulte.de
www.eco-schulte.de

© ECO Schulte GmbH & Co. KG - Änderungen vorbehalten
© ECO Schulte GmbH & Co. KG - Subject to change