

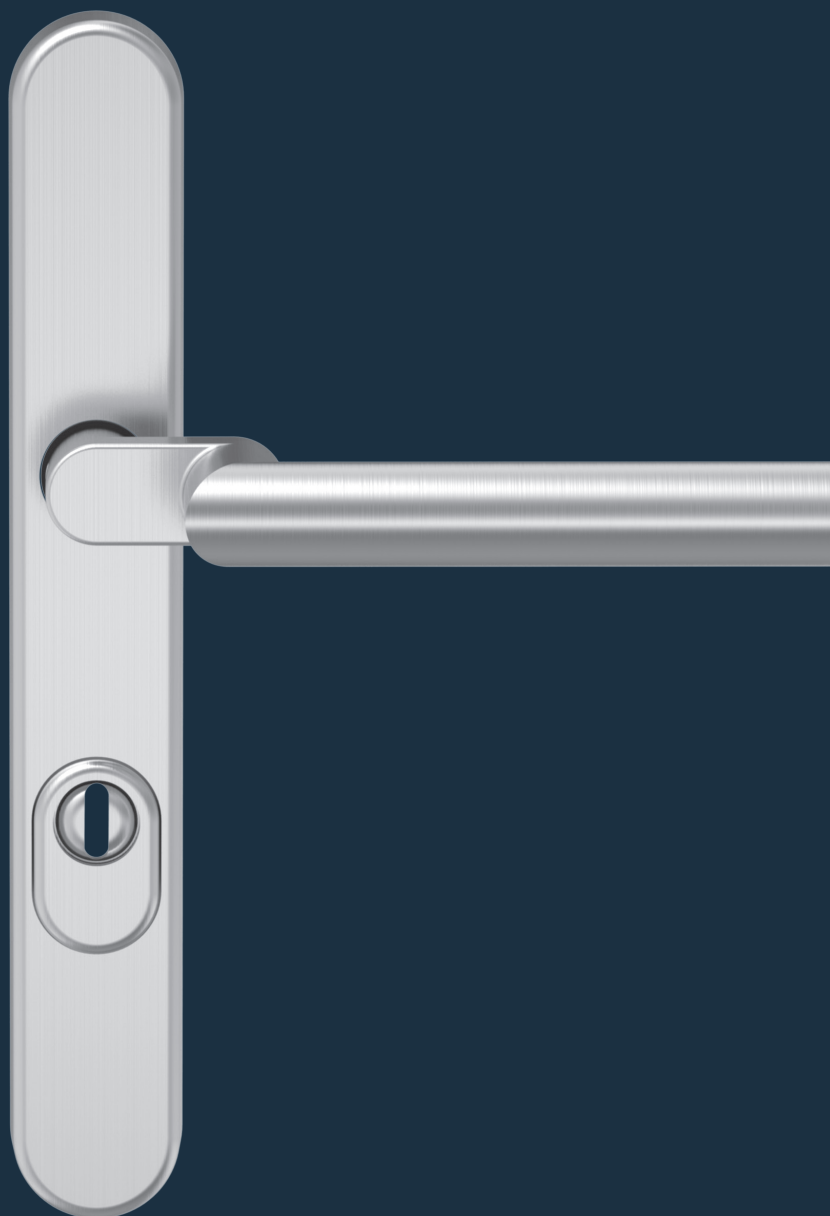

ECO D-315 Security handle sets

Product information



■ SYSTEM TECHNOLOGY FOR THE DOOR

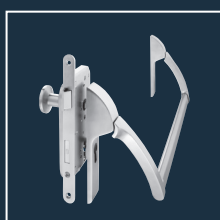
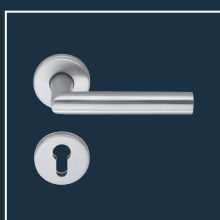
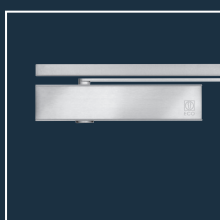

Product characteristics

Tested acc. to	EN 1906
With 9 mm spindle acc. to DIN 18273 fire protection tested	F
Tested acc. to	DIN 18 257
Fixable bearing	■
Steel base in inner and outer plate	■
Concealed continuous triple screw connection.	■
Inside with lever	■
DIN left / right	■

Classification key EN 1906

4	7	-	B1	1	4	2	U
---	---	---	----	---	---	---	---

■ Yes – No □ Option

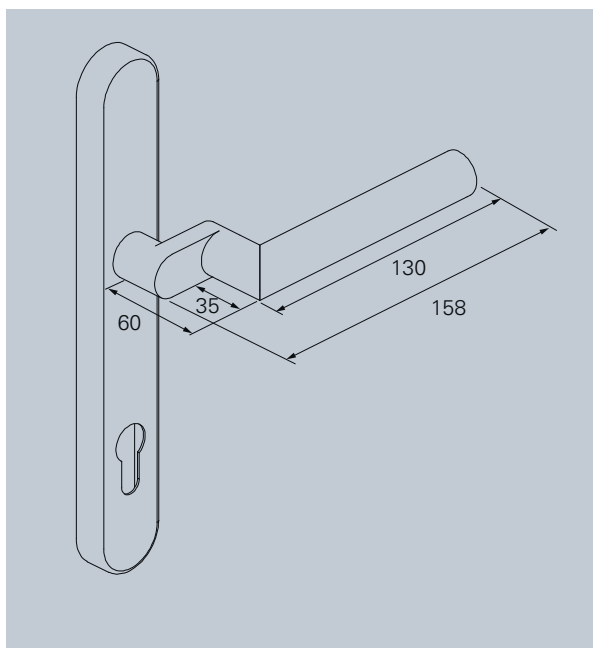

Profile frame door

Material:



ER
Stainless steel



Al
Aluminium

Bearing technology:



PRODUCT FAMILY D-300

Standard handle

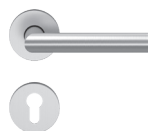

D-310

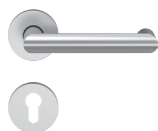

D-330

Long- / short plate handle



D-330



D-330

Oval rose handle



D-310



D-315

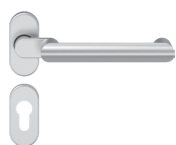

D-335

Security handle



D-310



D-315

Window handle



F-310

D-315 Security handle for profile frame doors ES 1

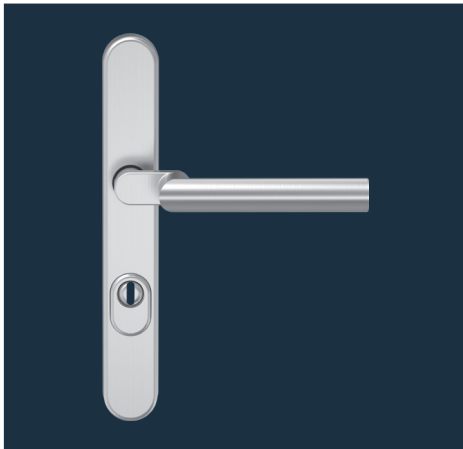

D-315 Security handle for profile frame doors with OGL

Fixed in maintenance-free friction bearing. Anti-burglary protection class ES 1 / class 2. Available with knob K-160.

Utilization category class 4. Positioning studs $\varnothing 8 \times 5$ mm

Outside: mounting height 15 mm. Distance 72 mm also available as FS version with 9 mm spindle. Positioning studs (short) $\varnothing 12 \times 9$ mm on request.

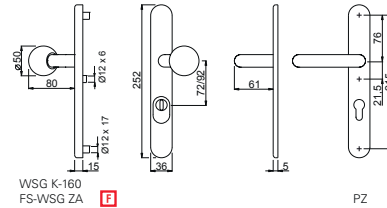

OGL – SECURITY HANDLE FOR PROFILE FRAME DOORS

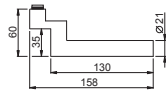

F = 4 7 - B1 1 4 2 U



	\varnothing	Distance	∇	Sets PZ		Sets ZA	
S	21 mm	72 mm	8 mm	852311.46	852341.46	852312.46	852342.46
F	21 mm	92 mm	9 mm	854511.46	854541.46	854512.46	854542.46
	21 mm	92 mm	10 mm	856511.46	856541.46	856512.46	856542.46

Finish: Stainless steel satin brushed, further colours on request

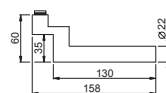

F = 4 7 - D1 1 4 2 U



	\varnothing	Distance	∇	Sets PZ		Sets ZA	
S	22 mm	72 mm	8 mm	882311.30	882341.30	882312.30	882342.30
F	22 mm	92 mm	9 mm	884511.30	884541.30	884512.30	884542.30
	22 mm	92 mm	10 mm	886811.30	886541.30	886512.30	886542.30

Finish: Aluminium anodized F1, further colours on request

The execution ZA is designed for cylinder projections of 11 – 14 mm.

S Standard handle for door thicknesses: 38 – 45 mm. **F** Fire protection doors for door thicknesses: 40 – 65 mm. Please advise door thickness when ordering.

ECO Schulte GmbH & Co. KG
Iserlohner Landstraße 89
D - 58706 Menden

Telefon: +49 2373/9276-0
Fax: +49 2373/9276-40

info@eco-schulte.de
www.eco-schulte.de

© ECO Schulte GmbH & Co. KG - Änderungen vorbehalten
© ECO Schulte GmbH & Co. KG - Subject to change