

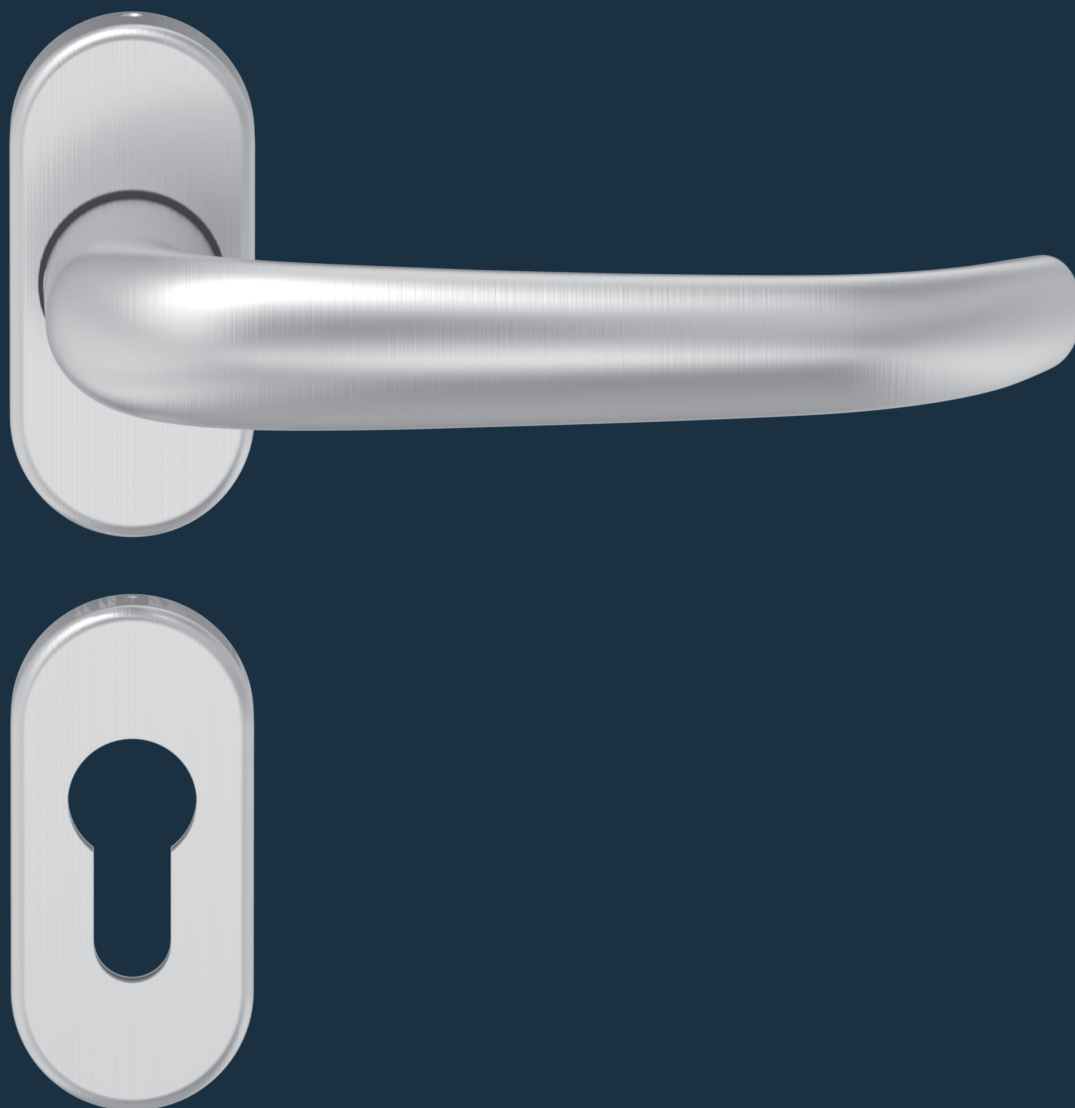

**ECO D-410**

Product information



■ SYSTEM TECHNOLOGY FOR THE DOOR

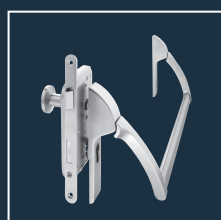
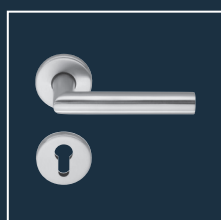

**Product characteristics**

Tested acc. to	<b>EN 1906</b>
With 9 mm spindle acc. to DIN 18273 fire protection tested	<b>F</b>
Lever form for escape doors and emergency exits	<b>EN 179</b>
Restoring spring	■
Fixable bearing	■
Steel base with positioning studs	■
Concealed through-screw technology	■
DIN left / right	■

Classification key EN 1906

4	7	-	B1	1	4	0	A
---	---	---	----	---	---	---	---

■ Yes – No □ Option



Profile frame door

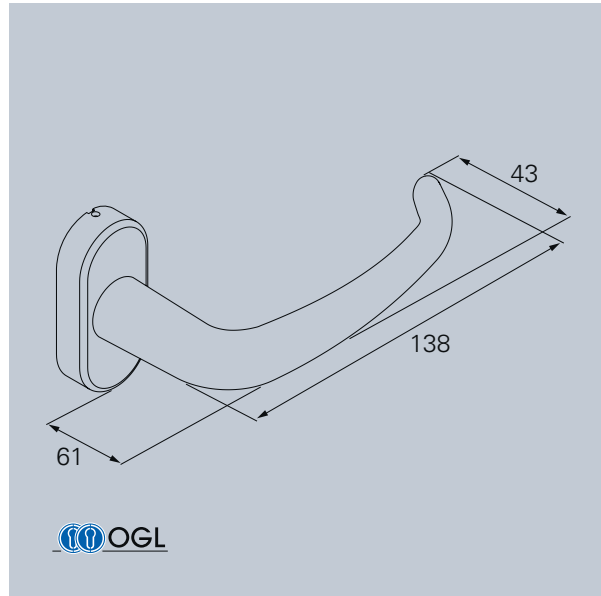

Material:

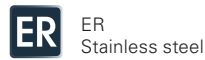

Bearing technology:



**PRODUCT FAMILY D-400**

**Standard handle**



D-410



D-490

**Long- / short plate handle**



D-410



D-410

**Oval rose handle**



D-410



D-415

**Window handle**



F-410

# D-410 Oval rose

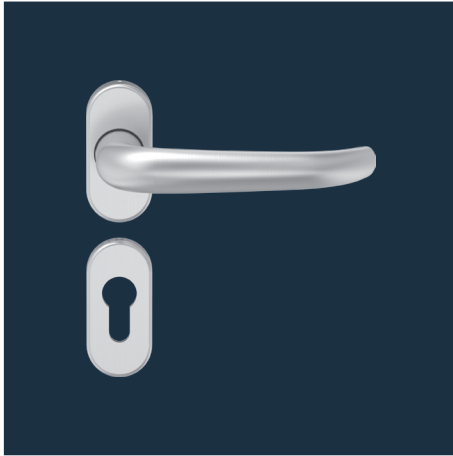

## D-410 Oval rose with OGL – friction bearing technology

Lever guidance consists of a closed, maintenance-free friction bearing with self-lubricating plastic. Available with fixed knob or turnable knob and powerful return spring. Flush ground rose, no bigger lever drillings necessary. Available with or without positioning studs.

Utilization category class 4, Positioning studs  $\varnothing 8 \times 5$  mm

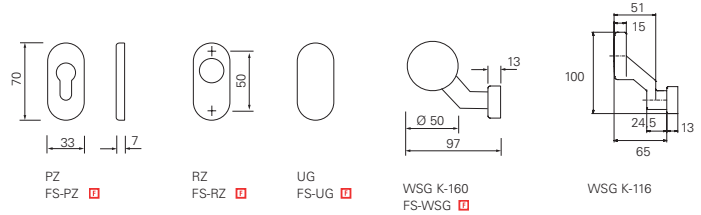

### OGL – OVAL ROSE HANDLE

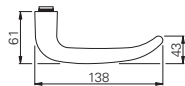

EN 1906 EN 179 F

F = 4 7 - B1 1 4 0 A/U

			Sets			Knob			Rose		
	$\varnothing$	$\nabla$									
	24 mm	8 mm	178462.46	185a05.46	185a10.46	178218.46	178200.46	178202.46	176850.46	176852.46	176851.46
	24 mm	9 mm	178460.46	385a05.46	385a10.46	178217.46	178200.46	178204.46	176850.46	176852.46	176851.46

Finish: Stainless steel satin brushed. PVD and polished on request

\*Base escutcheon incl. fire-proof plate

ECO Schulte GmbH & Co. KG  
Iserlohner Landstraße 89  
D - 58706 Menden

Telefon: +49 2373/9276-0  
Fax: +49 2373/9276-40

[info@eco-schulte.de](mailto:info@eco-schulte.de)  
[www.eco-schulte.de](http://www.eco-schulte.de)

© ECO Schulte GmbH & Co. KG - Änderungen vorbehalten  
© ECO Schulte GmbH & Co. KG - Subject to change