

Hinges for sanitary partitions

Nylon (spring) hinge ■ 24 / 28

Product information



■ SYSTEM TECHNOLOGY FOR THE DOOR

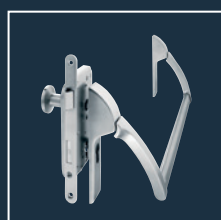
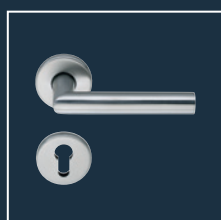
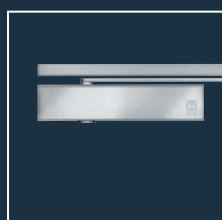

Product characteristics		
Execution	24 / 21	-
	24 / 28	■
Steel insert	3 mm	■
Two-piece with two nylon caps		■
Concealed fastening		■
Matching washers clipable (available as accessorie)	1 mm	-
	2 mm	-
	3 mm	■
■ Yes – No □ on request		



*RAL colour similar. Colour range see following page.

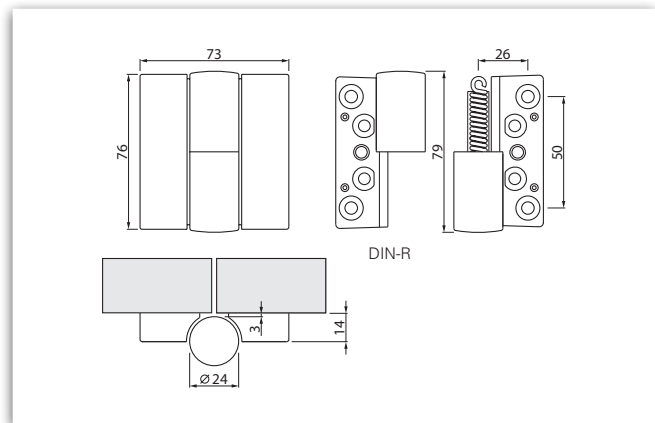

Dimensioning



Nylon (spring) hinge for unrebated doors	Article number	Description	Material
Nylon spring hinge	260600	24 / 28 DIN right	Nylon
Nylon spring hinge	260605	24 / 28 DIN left	Nylon
Washer	260383	3 mm / DIN right	
Washer	260384	3 mm / DIN left	

Sanitary partitions ■ Colour range

RAL colour similar* Standard

RAL 3003



01 red

RAL 9005

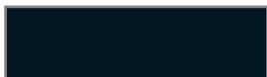

02 black

RAL 9010



08 white

RAL 5002



09 blue

RAL 5011 / 5013



21 dark blue

RAL 7030 / 7038



37 dark grey

On request

RAL 8022



04 dark brown

RAL 6029



05 green

RAL 1021



07 yellow

RAL 3007



18 dark red

RAL 6012

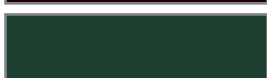

19 dark green

RAL 7043



20 grey

RAL 9016

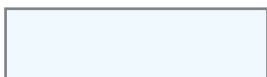

15 white



ECO Schulte GmbH & Co. KG
Iserlohner Landstraße 89
D - 58706 Menden

Telefon: +49 2373/92 76 - 0
Fax: +49 2373/92 76 - 40

info@eco-schulte.de
www.eco-schulte.de

© ECO Schulte GmbH & Co. KG - Änderungen vorbehalten
© ECO Schulte GmbH & Co. KG - Subject to change