



PRODUKTINFORMATION

KUNSTSTOFFBAND 24 / 21

■ SYSTEMTECHNIK FÜR DIE TÜR





Leistungskriterien		
Ausführung	24 / 21	■
	24 / 28	-
Einlage Stahlblech	3 mm	■
Zweiteilig mit 2 Kappen		■
Unsichtbare Befestigung		■
Unterlegscheiben (als Zubehör erhältlich)	1 mm	■
	2 mm	■
	3 mm	-

■ Ja - Nein □ auf Anfrage

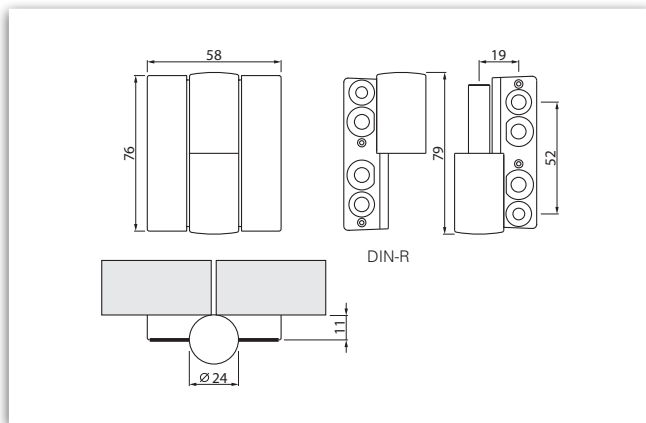

Bemaßung









*RAL-Ton ähnlich. Farbauswahl siehe Seite 443.



Kunststoffband für ungefältzte Türen	Artikelnummer	Beschreibung	Material
Kunststoffband	260300	24 / 21 DIN-R	Kunststoff
Kunststoffband	260305	24 / 21 DIN-L	Kunststoff
Unterlegscheibe	260379	1 mm	
Unterlegscheibe	260382	2 mm	

Sanitärrennwände ■ Farbauswahl

RAL-Ton ähnlich*	Standard	Nr.	Farbe
RAL 3003		01	rot
RAL 9005		02	schwarz
RAL 9010		08	weiß
RAL 5002		09	blau
RAL 5011 / 5013		21	dunkelblau
RAL 7030 / 7038		37	dunkelgrau

Auf Anfrage

RAL 8022		04	dunkelbraun
RAL 6029		05	grün
RAL 1021		07	gelb
RAL 3007		18	dunkelrot
RAL 6012		19	dunkelgrün
RAL 7043		20	verkehrsgrau
RAL 9016		15	verkehrsweiß



ECO Schulte GmbH & Co. KG

Iserlohner Landstraße 89

D-58706 Menden

Telefon +49 2373 9276 - 0

Telefax +49 2373 9276 - 40

info@eco-schulte.de

www.eco-schulte.de

■ SYSTEMTECHNIK FÜR DIE TÜR

