



ECO GBS 93





Product information

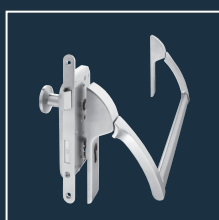
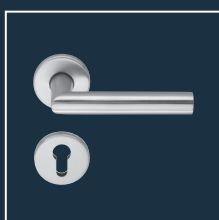

■ SYSTEM TECHNOLOGY FOR THE DOOR





| Product characteristics | | |
|--|---|--|
| Lock type | PZ-72 | ■ |
| | RZ-74 | □ |
| Backset | 55 | □ |
| | 65 | ■ |
| | 80 | ■ |
| | 100 | ■ |
| Panic function | B | ■ |
| | C | ■ |
| | D | ■ |
| | E | ■ |
| Face plate | Stainless steel | ■ |
| Face plate width | 20 round (rebate) | ■ |
| | 24 round (flush) | ■ |
| Hub | 9 mm | ■ |
| Suitable for the use on fire- and smoke control doors | F | ■ |
| Tested acc. to DIN / EN | EN 179  | EN 1125  |
| | DIN 18 250 | EN 12 209 |
| <input checked="" type="checkbox"/> Yes - No <input type="checkbox"/> On request | | |
|  Wooden door  Steel door | | |

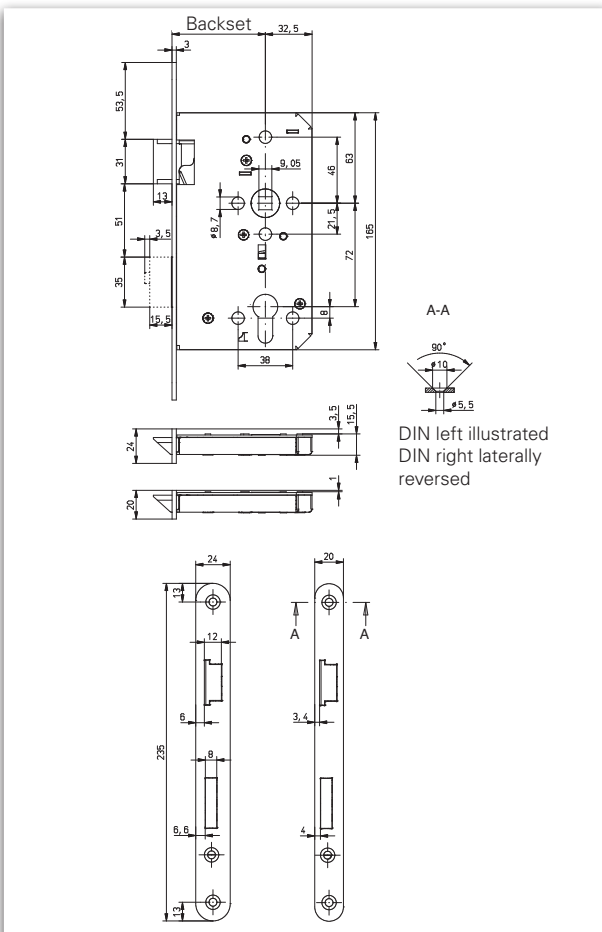

Description

- Panic mortise lock
- Tested and approved acc. to **EN 179, EN 1125, DIN 18 250** and **EN 12 209**
- For double-leaf wooden- and steel fire and smoke control doors
- Face plate square on request
- Related counter lock GBS 94

Individual stamping possible on request and at an extra charge.

**GBS 93 ■ Panic lock for double-leaf fire- and smoke control doors****Panic function E**

| Face plate finish | Backset in mm | Face plate form | Face plate 20 x 235 mm / PZ-72 (handle / knob execution) | | Face plate 24 x 235 mm / PZ-72 (handle / knob execution) | |
|-------------------|---------------|-----------------|--|-----------------|--|-----------------|
| | | | DIN left | DIN right | DIN left | DIN right |
| Stainless steel | 65 | round | 2093_ja02h34100 | 2093_ja02h34200 | 2093_ja02m34100 | 2093_ja02m34200 |
| | 80 | round | 2093_ma02h34100 | 2093_ma02h34200 | 2093_ma02m34100 | 2093_ma02m34200 |
| | 100 | round | 2093_qa02h34100 | 2093_qa02h34200 | 2093_qa02m34100 | 2093_qa02m34200 |

Panic function D

| Face plate finish | Backset in mm | Face plate form | Face plate 20 x 235 mm / PZ-72 | | Face plate 24 x 235 mm / PZ-72 | |
|-------------------|---------------|-----------------|--------------------------------|-----------------|--------------------------------|-----------------|
| | | | DIN left | DIN right | DIN left | DIN right |
| Stainless steel | 65 | round | 2093_ja02h35100 | 2093_ja02h35200 | 2093_ja02m35100 | 2093_ja02m35200 |
| | 80 | round | 2093_ma02h35100 | 2093_ma02h35200 | 2093_ma02m35100 | 2093_ma02m35200 |
| | 100 | round | 2093_qa02h35100 | 2093_qa02h35200 | 2093_qa02m35100 | 2093_qa02m35200 |

Panic function B

| Face plate finish | Backset in mm | Face plate form | Face plate 20 x 235 mm / PZ-72 | | Face plate 24 x 235 mm / PZ-72 | |
|-------------------|---------------|-----------------|--------------------------------|-----------------|--------------------------------|-----------------|
| | | | DIN left | DIN right | DIN left | DIN right |
| Stainless steel | 65 | round | 2093_ja02h33100 | 2093_ja02h33200 | 2093_ja02m33100 | 2093_ja02m33200 |
| | 80 | round | 2093_ma02h33100 | 2093_ma02h33200 | 2093_ma02m33100 | 2093_ma02m33200 |
| | 100 | round | 2093_qa02h33100 | 2093_qa02h33200 | 2093_qa02m33100 | 2093_qa02m33200 |

Panic function C

| Face plate finish | Backset in mm | Face plate form | Face plate 20 x 235 mm / PZ-72 | | Face plate 24 x 235 mm / PZ-72 | |
|-------------------|---------------|-----------------|--------------------------------|-----------------|--------------------------------|-----------------|
| | | | DIN left | DIN right | DIN left | DIN right |
| Stainless steel | 65 | round | 2093_ja02h32100 | 2093_ja02h32200 | 2093_ja02m32100 | 2093_ja02m32200 |
| | 80 | round | 2093_ma02h32100 | 2093_ma02h32200 | 2093_ma02m32100 | 2093_ma02m32200 |
| | 100 | round | 2093_qa02h32100 | 2093_qa02h32200 | 2093_qa02m32100 | 2093_qa02m32200 |

ECO Schulte GmbH & Co. KG
Iserlohner Landstraße 89
D - 58706 Menden

Telefon: +49 2373/9276-0
Fax: +49 2373/9276-40

info@eco-schulte.de
www.eco-schulte.de

© ECO Schulte GmbH & Co. KG - Änderungen vorbehalten
© ECO Schulte GmbH & Co. KG - Subject to change