

# PRODUCT INFORMATION

ECO HORIZON PROJECT HINGES  
OBX-18-2541/120 / -RC-A / -RC-B  
STANDARD & LIFTING LUG

■ SYSTEM TECHNOLOGY FOR THE DOOR





hinge with standard shape

Standard



OBX-18-2541/120

with lifting lug

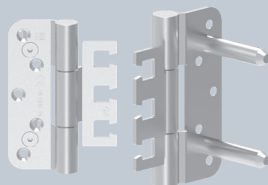

OBX-18-2541/120 TZ

Description

ECO Horizon project hinge OBX-18-2541/120

- For unrebated doors on wooden, steel or aluminium frames
- With OBX adjustable frame box adjustable in three dimensions
- Inner, firmly rotating axis
- Wear and maintenance-free ball bearing technology

- Perfectly closed hinge roll without cover head
- Suitable for fire doors
- Can be used DIN left / DIN right without modification
- EN 1935: Class 14 / 160 kg

Top view standard

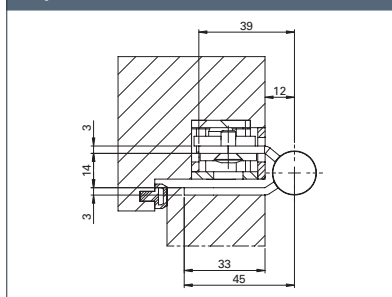

OBX-18-2541/120 for mortise rebated door 3D hinge	Dimensions	Art-No.
OBX-18-2541/120 ER	Ø 18 x 120 mm	5030053679
OBX-18-2541/120 TZ ER	Ø 18 x 120 mm	5030055307

Milling drawing standard

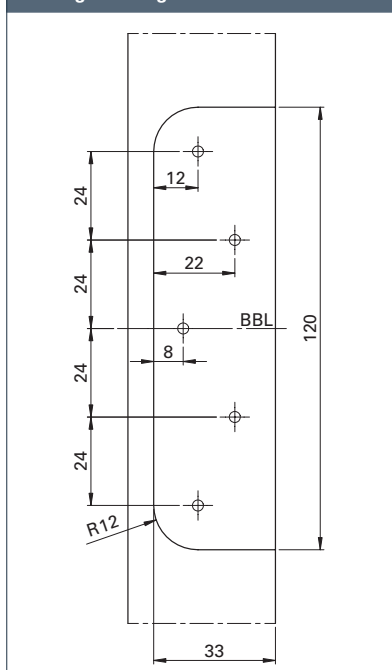

Milling drawing lifting lug (TZ)

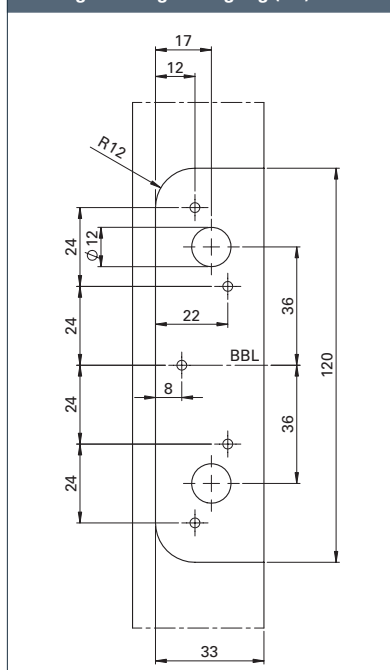



hinge with RC-A shape

Standard



OBX-18-2541/120-RC-A

with lifting lug

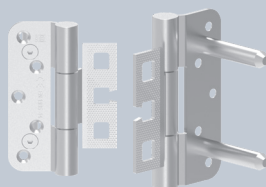

OBX-18-2541/120-RC-A TZ

Description

ECO **Horizon project hinge OBX-18-2541/120-RC-A**

- For unrebated doors on wooden, steel or aluminium frames
- With OBX adjustable frame box adjustable in three dimensions
- Inner, firmly rotating axis
- Wear and maintenance-free ball bearing technology

- Perfectly closed hinge roll without cover head
- Suitable for burglar-resistant elements
- Suitable for fire doors
- Can be used DIN left / DIN right without modification
- EN 1935: Class 14 / 160 kg

Top view standard

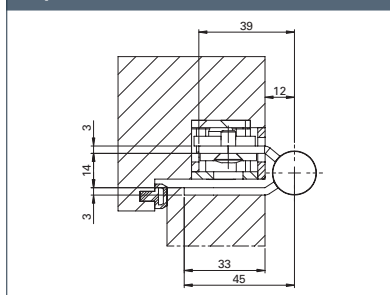

**OBX-18-2541/120-RC-A for mortise rebated door 3D hinge**

	Dimensions	Art-No.
<b>OBX-18-2541/120-RC-A ER</b>	Ø 18 x 120 mm	5030054325
<b>OBX-18-2541/120-RC-A TZ ER</b>	Ø 18 x 120 mm	5030055309

Milling drawing standard

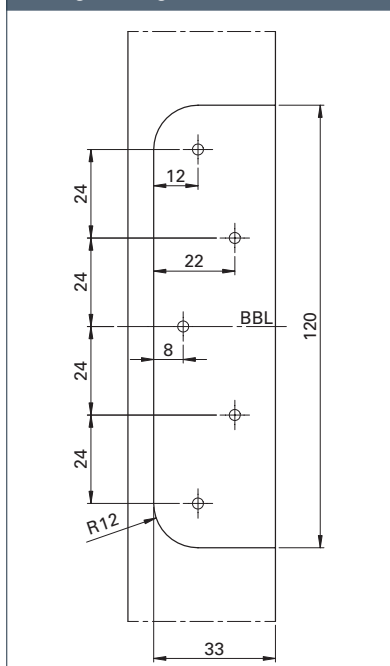

Milling drawing lifting lug (TZ)

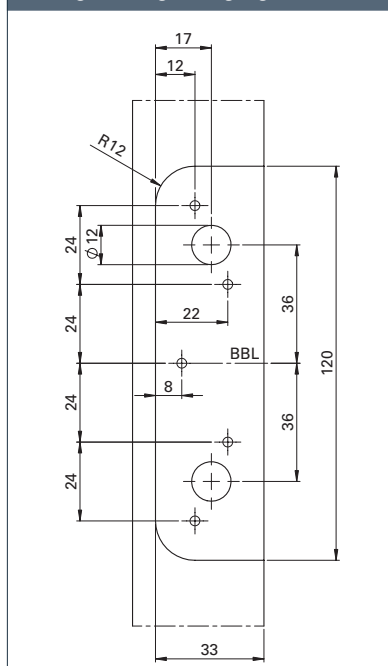

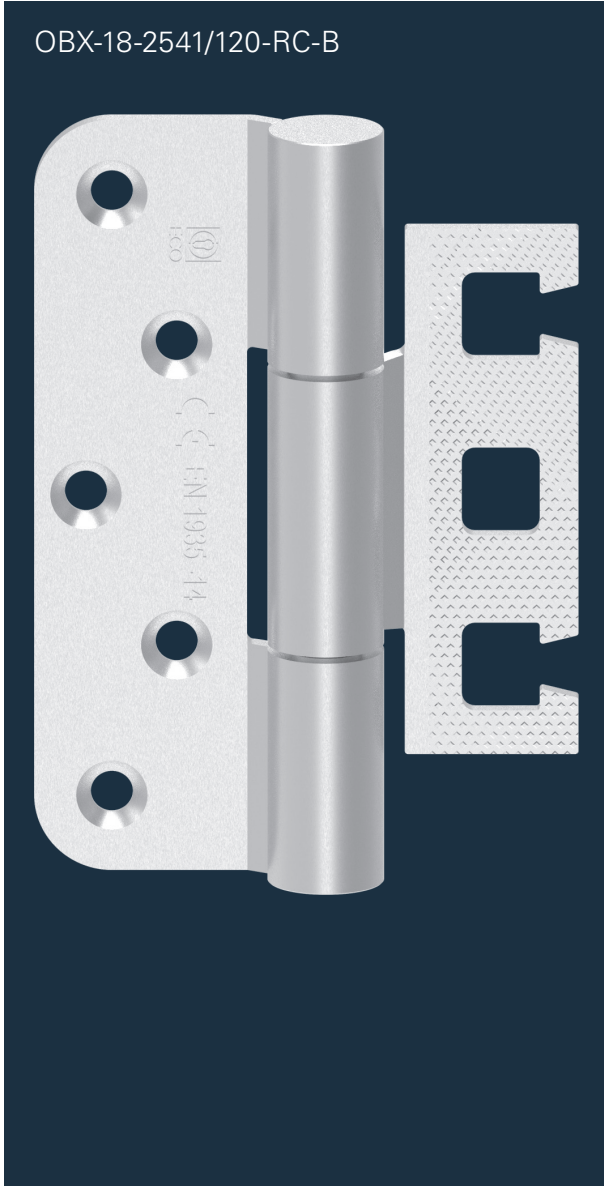

Product characteristics		
Size		120 mm
Ø Barrel diameter		18 mm
Material thickness		3 mm
Screws		5 x 50 mm
DIN left / DIN right		■
Milling diameter		24 mm
Milling length		120 mm
Milling depth		3 mm
Door types	rebated	-
	unrebated	■
Frame types	Wood	■
	Steel	■
	Aluminium	■
Suitable for fire doors	<b>F</b>	■
Loading capacity class 14 (door weight)	<b>EN 1935</b> <b>CE</b>	■
	acc. to Norm	160 kg
	ECO loading capacity	160 kg
Material	Stainless steel (ER)	■
Reception elements	For upright standing pillars	OBX-3001-3D
	For timber frames	OBX-3002-3D
	For steel frames	OBX-3011-3D OBX-3012-3D
	For aluminium frames	OBX-3021-3D

■ Yes - No ■ On request

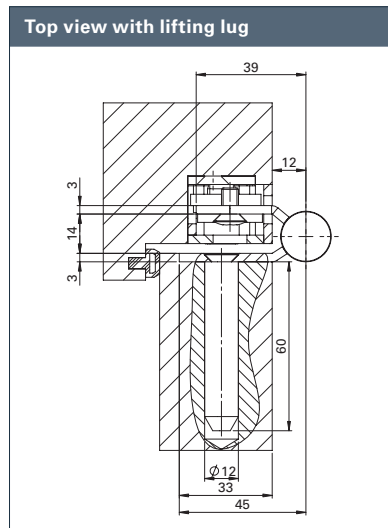
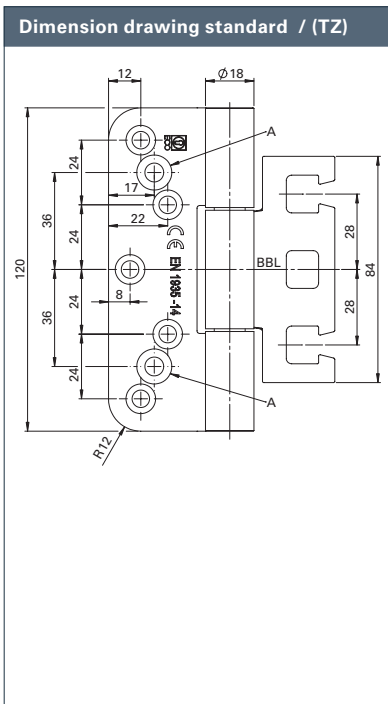

A: Only for version with lifting lug. ■ Adjustable framebox OBX 3D series must be ordered separately. Lifting lugs/screws must be ordered separately.

hinge with RC-B shape

Standard



OBX-18-2541/120-RC-B

with lifting lug

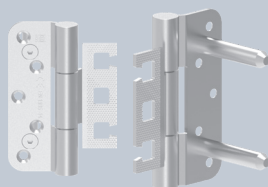

OBX-18-2541/120-RC-B TZ

Description

ECO **Horizon project hinge OBX-18-2541/120-RC-B**

- For unrebated doors on wooden, steel or aluminium frames
- With OBX adjustable frame box adjustable in three dimensions
- Inner, firmly rotating axis
- Wear and maintenance-free ball bearing technology

- Perfectly closed hinge roll without cover head
- Suitable for burglar-resistant elements
- Suitable for fire doors
- Can be used DIN left / DIN right without modification
- EN 1935: Class 14 / 160 kg

Top view standard

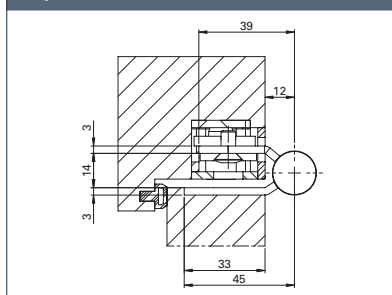

**F** **EN 1935** **CE** **ER**  Wooden door

OBX-18-2541/120-RC-B for mortise rebated door 3D hinge	Dimensions	Art-No.
OBX-18-2541/120-RC-B ER	Ø 18 x 120 mm	5030054327
OBX-18-2541/120-RC-B TZ ER	Ø 18 x 120 mm	5030055308

Milling drawing standard

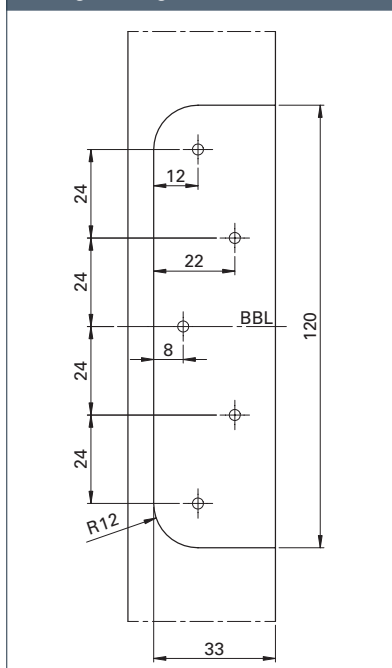

Milling drawing lifting lug (TZ)

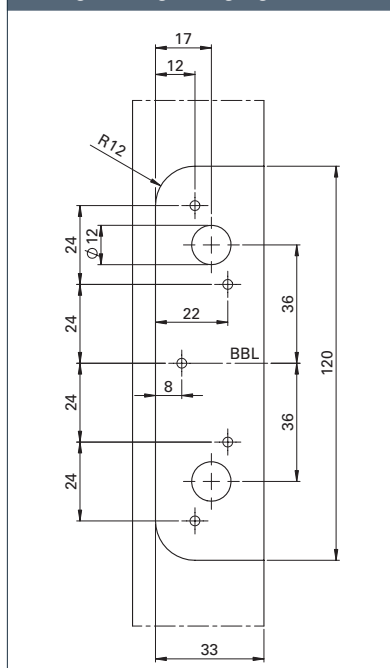

ECO **Schulte GmbH & Co. KG**

Iserlohner Landstraße 89

D-58706 Menden

Telephone +49 2373 9276 - 0

Telefax +49 2373 9276 - 40

[info@eco-schulte.de](mailto:info@eco-schulte.de)

[www.eco-schulte.de](http://www.eco-schulte.de)

■ SYSTEM TECHNOLOGY FOR THE DOOR

