

Swing door drive mechanism with fire protection rating

ETS 64-R

Operator manual

Original



Com. no. Pos. Construction year

Operator

Operating place

0548-991/62e
2019.10



TABLE OF CONTENTS

1	GENERAL REMARKS	4
1.1	Target group.....	4
1.2	Where to keep the operator manual	4
1.3	Addresses.....	4
2	SAFETY.....	5
2.1	Appropriate use	5
2.2	Safety notices.....	5
2.3	Safety regulations	5
2.3.1	Principles.....	5
2.3.2	Service.....	6
2.3.3	Safety devices.....	6
2.3.4	Malfunctions	6
2.3.5	Accessories/Spare parts	6
3	PRODUCT DESCRIPTION	7
3.1	General remarks	7
3.2	Standard application.....	8
3.3	Inverse application.....	8
3.4	Automatic closing sequence control.....	9
3.5	Control elements	9
3.6	Safety elements	9
3.7	Technical data	10
4	CONTROL.....	11
4.1	Main switch.....	11
4.2	Program selector.....	11
4.3	Operating modes	12
4.4	D-BEDIX (option).....	13
4.4.1	Keys	13
4.4.2	Symbols	13
4.4.3	Operating modes.....	14
4.4.4	Display of the door position	14
4.4.5	Menu level	15
4.4.6	Setting examples	16
4.4.7	Error display	17
4.5	KOMBI-D-BEDIX (option).....	18
5	SERVICE	19
5.1	Care/checking to be carried out by the operator	19
5.1.1	Switching off.....	19
5.1.2	Care	19
5.1.3	Checking.....	20
5.2	Maintenance/checking carried out by the after-sales service	20

6	TROUBLESHOOTING.....	21
6.1	With D-BEDIX / KOMBI-D-BEDIX (option)	21
6.1.1	Error display	21
6.1.2	Carrying out a Reset.....	21
6.2	Irregular functioning without error no.	22
7	SHUT-DOWN	23
8	DISPOSAL OF THE INSTALLATION.....	24
9	SETTINGS MADE BY THE AFTER-SALES SERVICE.....	25
10	APPENDIX.....	26
	• Declaration of incorporation according to machinery directive (by ECO)	

1 GENERAL REMARKS

The following basic documents are associated with this installation:

- Mounting and operating instructions 0548-990/62 onto the installation
- **Operator manual** **0548-991/62** by the operator
- Control booklet 0548-991/72 onto the installation

The present operator manual contains all the instructions needed for operation, maintenance as well as troubleshooting and is the basis for a faultless and safe operation of the installation.

The operator manual must be completely read and understood!

1.1 Target group

All the activities described in the operator manual may only be carried out by the operator or by appropriately instructed persons!

1.2 Where to keep the operator manual

The operator manual is handed over to the operator who has to keep it at an easily accessible place.

Handed over to the operator	Date
	Signature

1.3 Adresses

Distribution agent/
After-sales service

Distribution

ECO Schulte GmbH & Co. KG
Iserlohner Landstrasse 89
D-58706 Menden
Tel. +49 23 73 / 92 76-0
Fax +49 23 73 / 92 76-40
www.eco-schulte.de

2 SAFETY

2.1 Appropriate use

The swing door drive mechanism with fire protection rating ETS 64-R has been exclusively designed for operating swing doors with fire protection rating. Any other use beyond these application limits is deemed inappropriate and inadmissible!

In the event of an inappropriate use of this system, the safety of the user may be jeopardized and/or the installation be damaged. The manufacturer declines all responsibility for these injuries/damages!

2.2 Safety notices

The present instructions uses the following symbols and notes in order to point out certain residual dangers:



Warning:
Involving danger to life and limb.



Attention:
A situation where material could be damaged or the function impaired.



Note:
Hints which facilitate the work.

2.3 Safety regulations

2.3.1 Principles

- The installation has been calculated, designed and manufactured on the basis of the latest state-of-the-art technology and the generally recognized safety-relevant rules and regulations. It may only be operated if it is in perfect condition, taking into account the specifications of the present manual. Any use beyond the defined application limits is inadmissible!
- The installation is to be operated and maintained in such condition that the safety is guaranteed at all times. An integral part of this condition is the appropriate use, the compliance with the operating conditions prescribed by the manufacturer, as well as the regular service (maintenance/checking).
- In order not to create any dangerous squeezing and shearing points, no structural modification must be made within the door surroundings, without prior authorization from ECO Schulte GmbH & Co. KG. Furthermore, it is important that no objects (such as furniture, pallets, etc.) be placed in the vicinity of the door.
- All further interventions on and modifications of the installation that are not described in the present instructions are forbidden!
- The swing door drive mechanism with fire protection rating ETS 64-R may only be installed and operated in dry rooms. If this condition cannot be fulfilled, the customer must provide sufficient protection from moisture.

- Transparents door wings and fixed side panels (or their surfaces) must be clearly recognizable, e.g. by means of a permanent marking or dyed materials.
- Door sills or other protruding elements of the door system have to be marked with a warning sticker or appropriate marking.
- It is imperative for the customer to install a door leaf stop piece! The latter limits the opening motion of the door leaf and prevents it's being damaged in the manual operating mode. As an option, an open position stop piece can be integrated into the drive mechanism itself.

2.3.2 Service

In order to guarantee the safety of the users at all times, the installation must be checked with regard to its safe condition before the first commissioning and during normal operation, **at least once a year**, by a expert. The correct maintenance/checking must be confirmed by entering the date and signature into the control booklet.

In addition, fire protection installations need to be checked once a year by an authorized specialist. The correct checking must be confirmed by entering the date and signature to the maintenance control booklet for fixing devices.

2.3.3 Safety devices

It is inadmissible to bypass, shunt or disable the safety devices. Any defective safety devices may not be disconnected in order to be able to continue the operation of the installation.

2.3.4 Malfunctions

If any malfunctions occur which might be detrimental to the safety of the users, the installation must be immediately taken out of operation. It may only be taken back into operation after the malfunction has been repaired and all danger eliminated.

2.3.5 Accessories/Spare parts

A safe and reliable function of the installation can only be guaranteed if it is operated with the original ECO Schulte GmbH & Co. KG accessories/spare parts. ECO Schulte GmbH & Co. KG declines all responsibility for damages resulting from unauthorized modifications of the installation or from the use of foreign accessories/spare parts.

3 PRODUCT DESCRIPTION

3.1 General remarks

The swing door drive mechanism with fire protection rating ETS 64-R allows an automatic opening and closing of swing doors with fire protection rating. The door is opened either automatically or manually via the control elements. The closing is initiated upon expiry of the programmed hold-open time. If the Push-and-Go function is enabled, the door just requires a slight manual push upon which the drive mechanism carries out an automatic opening sequence.

The operating characteristics of the door can be determined via the program selector (selection of the operating modes).

A swing door installation may consist of the elements designated hereafter:

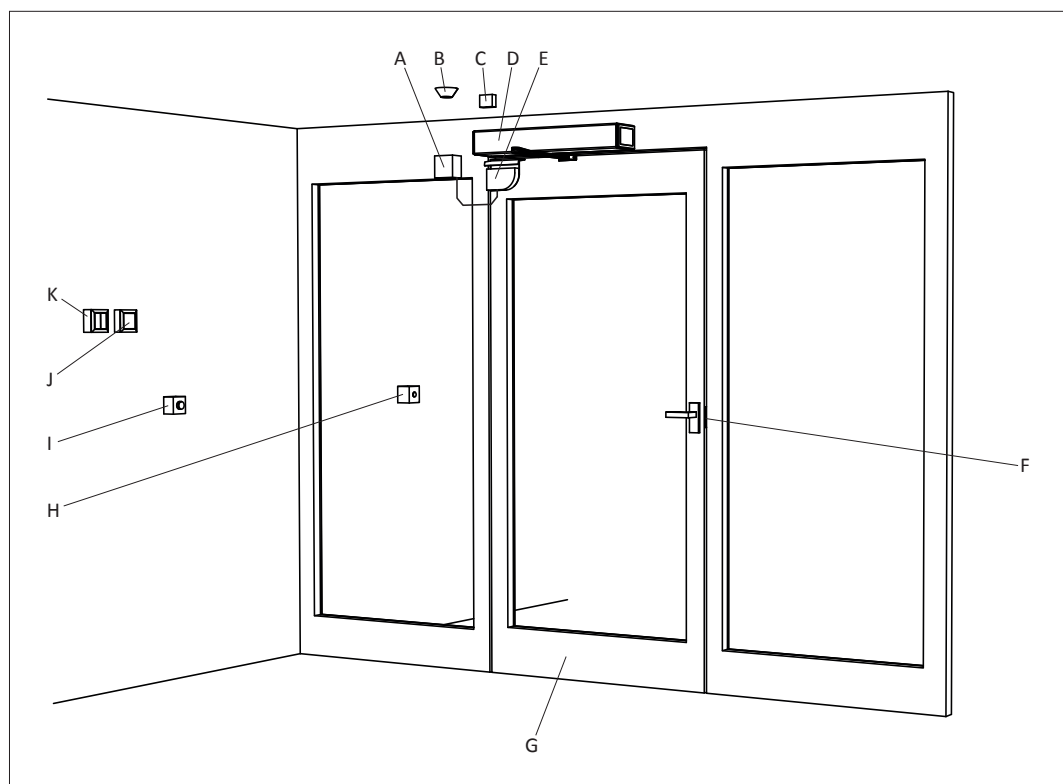

- A Branch box*
 - B Fire detector**
 - C Detector*
 - D Swing door drive mechanism with fire protection rating ETS 64-R
 - E Safety element*
 - F Electric lock*
 - G Door wing
 - H Key-operated pivoting switch*
 - I Push-button*
 - J Program switch*
 - K Manual triggering button "Close the door"***
or
Control button "Close the door/Restart"***
- * Option
** depending on the regulations valid in the country of application

3.2 Standard application

During normal operation, the opening and closing movements of the door leaf are motorized. The automatically opening is performed via opening elements. The automatically closing starts as soon as the programmed hold-open time has expired.

Function in the event of a fire alarm/a mains failure

The door leaf is closed from any position by means of spring power. The motor attenuation ensures a controlled closing.

3.3 Inverse application

The swing door drive mechanism ETS 64-R is also appropriate for inversed operation. This particular function can be separately programmed for each drive mechanism. The inverse application is suitable for smoke extraction from buildings (RWA = smoke and heat exhaust vent solution) as well as for escape and rescue ways. In the event of a power failure or a RWA, this functionality ensures that the door leaf is reliably opened.

During normal operation, the opening and closing movements of the door leaf are motorized. The automatically opening is performed via opening elements. The automatically closing starts as soon as the programmed hold-open time has expired.

Function in the event of a smoke alarm/a mains failure

The door leaf is opened from any position by means of spring power (unless it has not been locked). The motor attenuation ensures a controlled opening. An emergency power supply system is therefore not necessary.

Attention:

The inverse function (spring-powered opening) must not be used on hold-open devices or in fire-protection sections, as this function is contrary to the "self-closing" property (which is required by the standards)!

3.4 Automatic closing sequence control

For bi-parting installations, two separate ETS 64-R swing door drive mechanisms with fire protection rating are used, which are connected via the CAN bus system. In addition, fire protection installations require the installation of the mechanical closing sequence regulator ECO SRI.

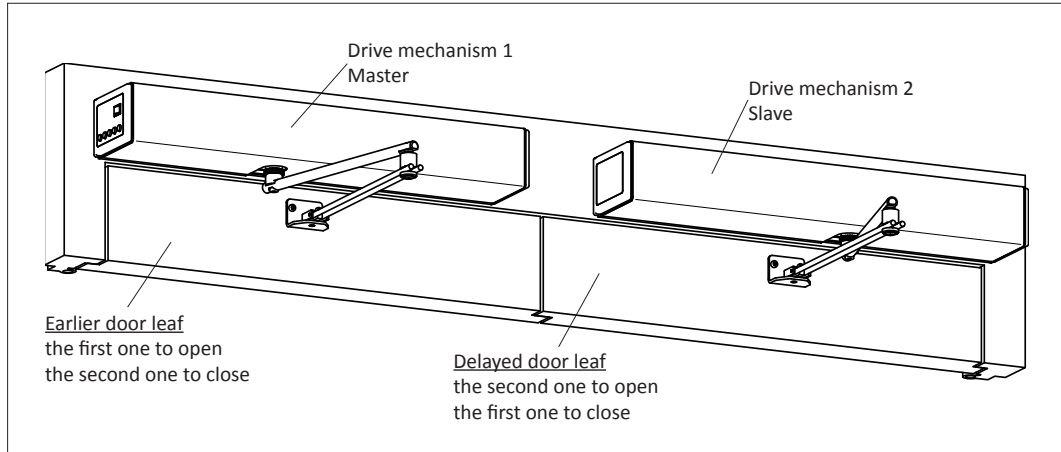

3.5 Control elements

The possible control elements are:

- Motion detector interior/exterior side
- D-BEDIX
- KOMBI-D-BEDIX
- Program selector
- Push-button
- Key-operated pivoting switch
- Remote radio control

3.6 Safety elements

The required safety elements must be installed in accordance with the EU directives as well as with the safety regulations valid in the country of application.



Attention:

We advise to use safety elements from the ECO Schulte GmbH & Co. KG product range. ECO Schulte GmbH & Co. KG cannot assume any functional guarantee if elements from other suppliers are being used!

The possible safety elements are:

- | | |
|---|--------------------|
| • Security detector side of door hinge | door leaf stops |
| • Security detector opposite side of door hinge | door leaf reverses |
| • Emergency stop button | door leaf stops |

3.7 Technical data

Drive mechanism	Standard GSd (special gear for sliding rods pushing function)
Power transmission	Normal rods Sliding rods
Dimensions drive mechanism	Height 95 mm Width 690 mm Depth 120 mm
Weight drive mechanism	10,5 kg
Ambient temperature	-15...+50 °C
May only be used in dry rooms	max. relative humidity 85 %
Protection type	IP 40 (IP 42*)
Operating voltage	230 VAC (+10/-15 %), 50 Hz, 10/13 A
Power consumption drive mechanism	max. 560 W
Motor power rating	100 W
Power supply external consumer	24 VDC ($\pm 10\%$), 2 A
Torque output shaft	80 Nm permanent 240 Nm max.
Distance door hinge - Output shaft	280 mm
Lintel depth	normal rods max. 240 mm sliding rods DIBt check. -30/+30 mm pl -30/+70 (+190) mm ps -30/+60 (+190) mm
Door opening angle	max. 105°
Weight of door leaf	max. 250 kg
Width of door leaf	EN 3...6 (851...1'400 mm)
Opening speed	2,4...20 s adjustable (max. 40°/s)
Closing speed	2,4...20 s adjustable (max. 40°/s)
Range of the accelerating function (forceful closing) (without mains power)	5...15° stepless adjustable (mechanical)
Motor damping (without mains power) within the range of the accelerating function (forceful closing)	stepless adjustable (adjusting trimmer)
Hold-open time	0...60 s
Hold-open time Night	0...180 s

* For obtaining the protection type IP 42, the drive mechanism covering must be sealed all around!

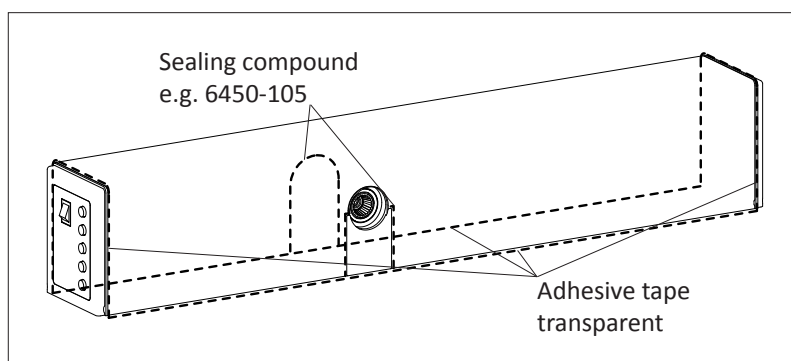

4 CONTROL

4.1 Main switch

The drive mechanism is supplied with a built-in main switch (A). This main installation switch enables you to disconnect the power supply from the drive mechanism. The door leaf then is closed from any position by means of spring power (Invers = spring opening, unless the door leaf has not been locked). The motor attenuation ensures a controlled closing (Invers = opening).

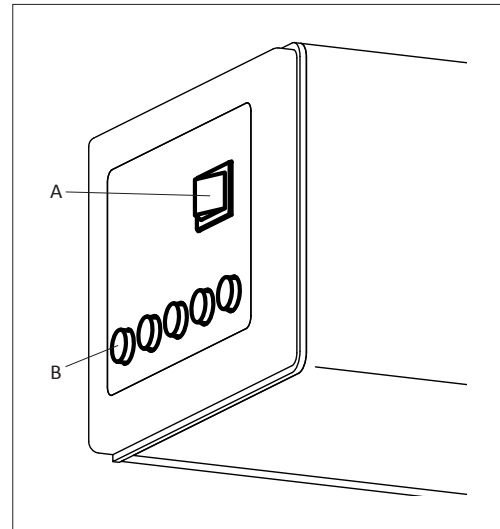

4.2 Program selector

The drive mechanism is supplied with a built-in program selector (B), which allows enabling the operating modes AUTOMATIC, NIGHT, OPEN, MANUAL and EXIT. The presently enabled operating mode is identified by the illuminated key.



Note:

In the event of a pending fatal error, alle the keys shortly flash up. In the event of a fire alarm, the red LED in the other side cover lights up.

Acknowledge the fire alarm (either by means of a connected button or by pressing and holding for a certain time a program key in the side cover). In the event of bi-parting installations, this alarm must be reset for both drive mechanisms.

Key lock (3 versions)



Note:

Must be programmed by your customer service!

1 Fix

One particular program setting has been predefined by default. This setting can only be overridden by an external program switch or a timer.

2 Toggle

Locking:

Press the activ program key during at least 5 seconds. The locking is signaled by a short blip.

Unlocking:

Press the activ program key during at least 5 seconds. The deactivation is signaled by two short blips.

3 Time

Locking:







If the program keys have been activated within a period of 5 minutes, the are automatically locked.

Unlocking:

Press the active program key during at least 5 seconds. The deactivation is signaled by two short blips.

4.3 Operating modes

The following operating modes can be enabled by means of the program selector:

	<p>AUTOMATIC Automatic opening via the opening elements inside/outside + Key. Automatic closing upon expiration of the adjustable hold-open time.</p>
	<p>NIGHT The door leaf can only be opened via the opening element Key (key-operated switch outside).</p>
	<p>OPEN The door leaf is automatically opened and remains in the OPEN position.</p>
	<p>MANUAL The drive mechanism and the control elements are switched off. The door leaf can be manually opened. The door leaf is closed by spring power from any position (Invers = spring opening, unless the door leaf has not been locked).</p>
	<p>EXIT The door leaf can only be opened via the opening elements inside and Key.</p>
	<p>Setting-up procedure (Teach) Completely close the door leaf (Invers = open). Hold the keys MANUAL and EXIT simultaneously depressed (during at least 5 seconds). All the pending errors will be deleted and a setting-up procedure (Teach) is carried out.</p>

4.4 D-BEDIX (option)

The different operating modes can be directly enabled by means of the D-BEDIX. In addition, it provides easy programming of the most important door settings.

The operating modes, menu settings as well as possible errors are displayed in a clearly arranged synopsis.

The D-BEDIX is connected to the control unit ETS 64-R via a screened two-core connection cable (e.g. U72M or EIB-Y(St)Y, max. length 50 m).

Only one D-BEDIX can be connected per door installation.

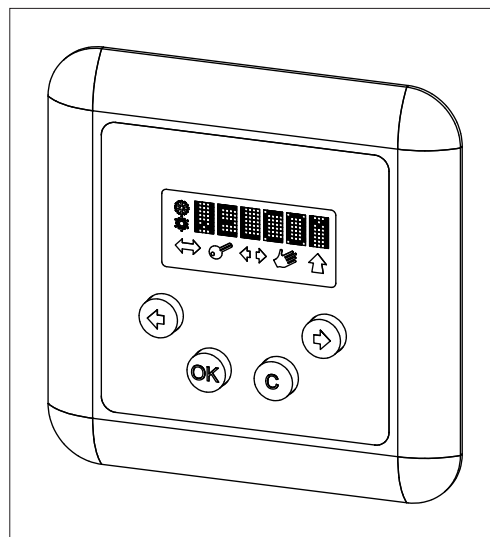

4.4.1 Keys





	C-key (Cancel) <ul style="list-style-type: none"> • Exit the menu • Invalidate entry.
	OK-key <ul style="list-style-type: none"> • Confirm the selection • Confirm the entry.
	Arrow keys <ul style="list-style-type: none"> • Navigate within the menus • Short simultaneous actuation of both keys = acces to the menu level.

4.4.2 Symbols

	Operating mode symbols <ul style="list-style-type: none"> • Show the possible operating modes (see chapter: Operating modes). 	
	Selection frame (active and preselected operating mode) <ul style="list-style-type: none"> • Shows what has been presently selected. 	
	Selection frame (active operating mode) <ul style="list-style-type: none"> • Shows what has been presently selected but is still inhibited. A control element with higher priority (e.g. key-operated switch) determines the operating mode. 	
	Bar (preselected operating mode) <ul style="list-style-type: none"> • Shows the preselected operating mode. 	

4.4.3 Operating modes

With the D-BEDIX, the following operating modes can be selected by means of the corresponding symbols:

	AUTOMATIC Automatic operation. The installation can be locked.
	NIGHT The installation is locked ¹ . As opening commands, only the key-operated impulse switch is accepted. The delayed switchover to the operating mode NIGHT can be activated by means of parameter TdNigt. Function: If the program selector switch is changed to the operating mode NIGHT from any random operating mode, the internal radar will still remain active during the programmed time TdNigt (EXIT).
	OPEN The installation is opened and remains in the open position.
	MANUAL The installation stops. The swing door leaf is released and can be manually opened and closed.
	EXIT One-way traffic from inside towards the outside. The installation is locked ² (shop closing switching mode).

¹ Provided that the locking mechanism (optional) is installed.

² Each operating mode can be locked (this is configurable).

4.4.4 Display of the door position

The following door positions are represented on the D-BEDIX display:

<REF?>	Waits for reference switch
< ?? >	Unknown
><	Closed
>##<	Closed and locked
<< >>	Opening
< >	Open
>> <<	Closing
==	Stopping

4.4.5 Menu level

Short and simultaneous actuation of both arrow keys (=access to the menu level).

Select the desired menu item by means of the arrow key.

Confirm by means of the OK key.

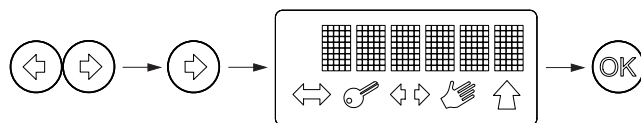

Display	Description
PARAMETER	Setting the motional parameters *
CONFIG	Setting the functionalities *
DOUBLE DOOR	Setting the closing sequence and interlock function *
DIAGNOSTICS	Diagnostic tool
ERROR ACTIVE	Active pending errors
ERROR HISTORY	Formerly active errors
REINIT	Carry out a re-initialization *
BLOCK/UNBLOC	Lock/unlock keys
TEACH	Initiate a setting-up procedure ⇒ make sure that the door leaf is completely closed.

* password protected ⇒ settings only made by the after-sales service

4.4.6 Setting examples

Changing the operating mode

Select the desired symbol by means of the arrow key (symbol starts flashing).
Confirm with the OK key (frame/bar switch over).

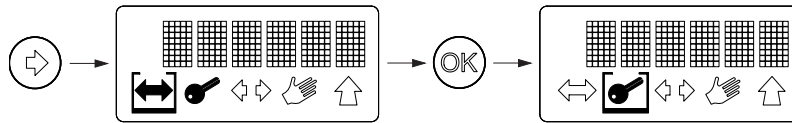

Preselecting the operating mode

An overriding switch is active and determines the operating mode (only the selection frame is visible, the bar underlines the preselected operating mode). Now you can select the operating mode you want to be active upon cancellation of the overriding switch:
Select the desired symbol by means of the arrow key (symbol starts flashing).
Confirm with the OK key (bar switches over).

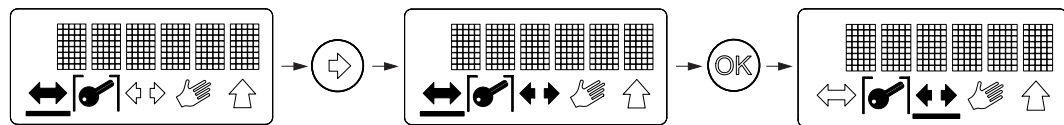

Enabling the keylock

Short simultaneous actuation of both arrow keys (= access to the menu level).
By means of the arrow key, select BLOCK.
Confirm with the C-key and the right-hand arrow key.

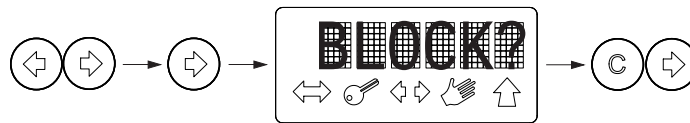

Temporarily disabling the keylock (60 s)

Short simultaneous actuation of the C-key and the right-hand arrow key.



Disabling the keylock

Short simultaneous actuation of the C-key and the right-hand arrow key.
Short simultaneous actuation of the arrow keys (= access to the menu level).
By means of the arrow key, select UNBLOC.
Confirm with the C-key and the right-hand arrow key.

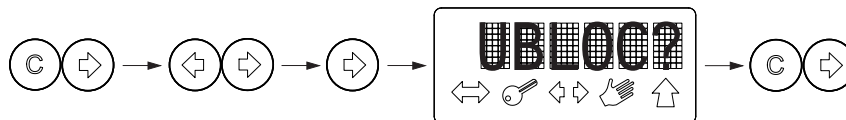

Parameters (hold-open timeday)

Short simultaneous actuation of the arrow keys (= access to the menu level).

By means of the arrow key, select TOEx.

Confirm with the OK key.

By means of the arrow key, change the value.

Confirm with the OK key.

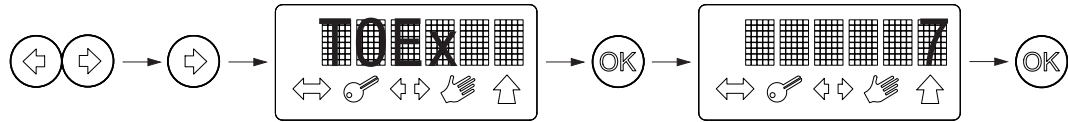
**Teach**

Completely close the door leaf.

Short simultaneous actuation of the arrow keys (= access to the menu level).

By means of the arrow key, select Teach.

Confirm with the OK key.

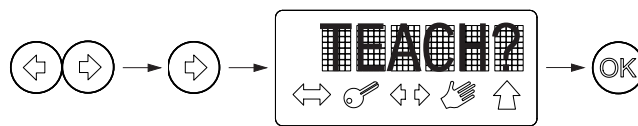
**4.4.7 Error display**

In the event of an error, the display shows (alternating with the door position status) the presently active error number (e.g. E20/01).

Error list: see chapter Troubleshooting.

This sequence will be repeated until the error has been eliminated.

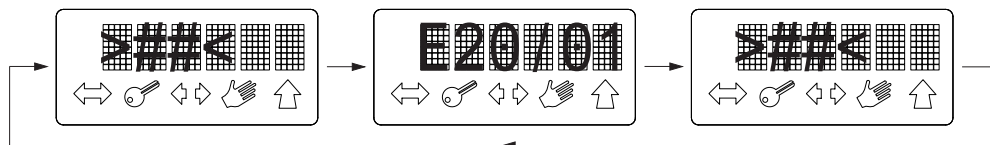

4.5 KOMBI-D-BEDIX (option)

In addition to the functions of the D-BEDIX, the KOMBI-D-BEDIX contains a key-operated switch (round or profile cylinder) with the following function:

Lockout of the KOMBI-D-BEDIX against unauthorized use.

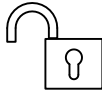

Free



Locked

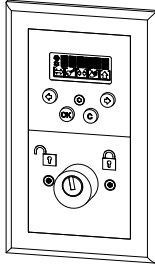
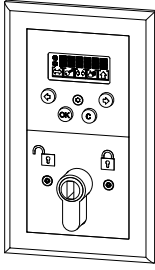

If this lockout is enabled, all the keys are shortly lit (as a confirmation of the lockout).

 <p>Round cylinder</p>	 <p>Profile cylinder</p>
<p>Cylinder: to be supplied by customers</p>	
	
<p>KABA 1514 SEA 1.043.0 DOM 2222H ix5 Driver with 8 adjus. possibilities</p> <p>KESO 11.014.045 KESO 21.014.045 KESO 31.014.045 Adjustable beard E201</p>	<p>KESO 21.214.040 Adjustable beard E200</p> <p>DOM 333 ix-5 Driver with 8 adjusting possibilities</p> <p>BKS 8900 N BL 31 BKS 3101 N BL 31 BKS 3301 N BL 31</p> <p>ZEISS IKON 0040 ZEISS IKON 5040 ZEISS IKON 5044 ZEISS IKON 6044 ZEISS IKON 7044</p>

5 SERVICE

5.1 Care/checking to be carried out by the operator



Warning:

Disconnect the installation before carrying out any work on the swing door!

5.1.1 Switching off

- Select the operating mode MANUAL
or
- Switch-off the main switch.

5.1.2 Care

- Clean the floor within the area of the door wing.
- Clean the outside of the drive mechanism covering with a moistened rag.



Warning:

Do not use running water or high-pressure machines for cleaning the drive mechanism!



Attention:

Do not use any metal brushes or chemical products for cleaning the installation!

5.1.3 Checking

The installation must be checked at regular intervals, at least every 2 months (checking of the different elements as far as these are included in the installation):

- When the door wing is moved by hand, can you hear any unusual grinding or screeching noises?
- Check the function, the free access to and identification of the emergency stop button (optional).
- Check the correct fastening of the drive mechanism covering.



Attention:

Please contact immediately your after-sales service if you detect a damage or malfunction that you cannot repair yourself.

5.2 Maintenance/checking carried out by the after-sales service



Warning:

In order to guarantee the safety of the users at all times, the installation must be checked with regard to its safe condition before the first commissioning and during normal operation, **at least once a year**, by a expert. The correct maintenance/checking must be confirmed by entering the date and signature into the control booklet.

In addition, fire protection installations need to be checked once a year by an authorized specialist. The correct checking must be confirmed by entering the date and signature to the maintenance control booklet for fixing devices.



Note:

We recommend to conclude a maintenance contract with the manufacturer of the installation, respectively with his authorized distribution partner.

6 TROUBLESHOOTING

6.1 With D-BEDIX / KOMBI-D-BEDIX (option)

6.1.1 Error display

The control unit recognizes various error situations and conditions and displays them on the D-BEDIX / KOMBI-D-BEDIX panel by means of an error number. Fatal errors (door in standstill) will be automatically shown on the display when the installation is switched on.

6.1.2 Carrying out a Reset

Before carrying out a Reset, make sure to note the error number.

- Upon selection and confirmation by means of the OK key, the drive mechanism automatically re-adjusts itself.

Should you not succeed in eliminating the error, please call the after-sales service (Address: see chapter 1).



Note:

In order to perform a precise error diagnostic, the after-sales service absolutely needs to know the error-no. which is displayed! Hereafter you will find further instructions about how you can try to eliminate the error, or if it is necessary to contact the after-sales service.

6.2 Irregular functioning without error no.

Malfunction	Analysis	Possible cause	Elimination
Drive mechanism does not function	Program selector	On position MANUAL	Select AUTOMATIC
	Main switch	Switched OFF	Switch ON
	Customer-supplied fuse	Defective	Replace
	Drive unit is heated up	Temperature monitor has been triggered	Wait 5...10 minutes
Drive mechanism does not open	Main switch	Opening element defective	Contact the after-sales service
	Door wing cannot be opened by hand	Electric lock does not release	Check/Contact the after-sales service
	Presence of an obstacle	Safety element has been triggered	Remove the obstacle
	Emergency stop button	Emergency stop button is active	Release the emergency stop button
	The red LED in the side cover lights up	Fire alarm/Mains failure	Acknowledge the alarm (either by means of a connected button or by pressing and holding for a certain time a program key in the side cover)
Drive mechanism does not close	Main switch	Opening element is active	Check/Contact the after-sales service
	Presence of an obstacle	Safety element has been triggered	Remove the obstacle
Wing moves jerkily	Main switch	–	Contact the after-sales service

7 SHUT-DOWN

No particular measures need to be taken for de-commissioning the installation.

If the swing door drive mechanism with fire protection rating will not be used during at least 1 month, it is recommended to pull out the mains plug.

For taking the installation back into operation, all you have to do is to plug in the mains cable and select the operating mode. If the swing door drive mechanism with fire protection rating has been out of operation for more than 3 months, we recommend to have the re-commissioning carried out by your after-sales service (address: see chapter 1).

8 DISPOSAL OF THE INSTALLATION

An ecologically acceptable disposal of the installation is ensured if the different materials are separated and recycled. No particular measures are required for the protection of the environment. However, the relevant legal prescriptions applicable for the installation site have to be complied with!

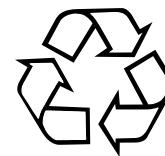

We advise you to entrust your after-sales specialists with the dismantling and disposal of your installation. They will guarantee that the work is carried out according to the rules of environmental protection.

10 APPENDIX

The following documents are added as an appendix to this operator manual:

- Declaration of incorporation according to machinery directive (by ECO)